



Product Catalogue.

Gas Welding, Cutting, Soldering and Heating.

Contents.



| | | | |
|-------------------|----|--|---|
| Chapter 1. | 05 | How to Order | |
| Introduction. | 06 | X11 Overview | |
| | 08 | X21 Overview | |
| | 10 | MIG/MAG and TIG welding – overview | |
| | 11 | Toolboxes | |
| <hr/> | | | |
| Chapter 2. | 13 | AGA Regulators | |
| Regulators. | 18 | Regulators for Gas Shielded Arc Welding | |
| | 22 | Accessories: Regulators for Gas Shielded Arc Welding | |
| | 24 | Regulators for high pressure and flows | |
| <hr/> | | | |
| Chapter 3. | 27 | X11 PRO Series | 45 |
| Toolboxes. | 28 | X11 Overview | 46 |
| | 34 | X21 PRO Series | 48 |
| | 35 | X21 Overview | |
| <hr/> | | | |
| Chapter 4. | 50 | Premium Cutting Nozzles | 55 |
| Cutting Nozzles | 51 | Function and Maintenance | 56 |
| – Gouging. | 52 | COOLEX® – 3-Cone Sealed Cutting Nozzles for Pressure Torches | 57 |
| | 53 | Premium Nozzles for X21 | 58 |
| | | | 58 |
| | | | Gouging X21 Injector |
| | | | Gouging |
| | | | Gouging X21 Injector |
| | | | Premium Nozzles for X21 |
| | | | Gouging X21 |
| <hr/> | | | |
| Chapter 5. | 61 | Flashback Arrestor, Double Outlet, Two Regulators – One Gas Cylinder | 67 |
| Accessories. | 63 | Safety Goggles | 69 |
| | 64 | Cylinder Carts | 70 |
| | 66 | Welding Helmet, Warning Signs, Leak Detection Spray TL4 | 73 |
| | | | Mounting brackets for cylinders, Back frame, Gloves, Welding hose |
| | | | AGA Quick Coupling |
| | | | Hose Fittings and Cap Nuts, Cleaning Needles |
| | | | Jet Freezer |
| <hr/> | | | |
| Chapter 6. | 77 | Regulators | 79 |
| Propaline Propane | 77 | Hose Brake Valves | 79 |
| equipment. | 78 | Handles | 79 |
| | 78 | Handles Accessories | 80 |
| | 78 | Extension Pipes Accessories | |
| | | | Heating Torches |
| | | | Soldering Torch |
| | | | Brazing Torch |
| | | | Heating and Brazing Kits |
| <hr/> | | | |
| Chapter 7. | 82 | Equipped for Gas Welding | |
| Additional | 83 | Checklist | |
| information. | 84 | Safety | |
| | 85 | Information | |

Introduction.

Equipment and accessories for welding, cutting, soldering and heating.

AGA offers a wide range of cutting and welding products in the Nordic countries and Baltics that are intended for welding, cutting and soldering techniques, as well as the related processes using fuel gases, oxygen, shielding gases or air.

When supplying a broad line-up of welding equipment, compliance with safety regulations must be ensured in order to protect the individual working with gases.

All equipment products are designed and manufactured according to EN and CE standards with safety in focus. By purchasing AGA gas equipment, you are making an investment in your future. Our premium products will help to increase your productivity in a manner that is ergonomic and user-friendly.

All AGA gas regulators, torches, torch shanks and cutting attachments come with a two year conditional warranty.



How to Order.

Doing business with us is easy. To place an order or get information, you can contact us in a way that suits you through our various touch points.

You can check your nearest AGA agents from your local AGA website.

Interested in ordering online?

Please visit your local AGA website to see the available online ordering options.

General Information

Quality system

AGA is ISO 9001 certified for our work with sales, distribution and the manufacture of industrial and medical gases, as well as associated equipment. This means that all our products and services must be of sufficient quality to meet both our customers' needs and the requirements of the authorities.

Environmental Policy

AGA is certified in accordance with ISO 14001. AGA's objective is to lead the way in the field of environmentally-conscious industrial gas engineering; for example, by using gas engineering as a basis for helping customers to introduce new, improved technologies and relieve the load on the environment.

Miscellaneous

It is important for purchasers and users to keep up-to-date with regards to which safety regulations apply to the use and transport of equipment and gases. AGA is not responsible for any personal injury and/or damage to property that may arise during the use of products contained in the catalogue or in conjunction with work processes.

The version, design and function of the products may differ from the information presented in this catalogue as a result of product development and new requirements from the authorities. AGA reserves the right to make amendments within its product range. Local deviations may occur.

For further information, visit our websites:
www.aga.se, www.aga.fi, www.aga.no, www.aga.dk,
www.aga.lt, www.aga.lv, www.aga.ee, www.aga.is



X11 Overview.

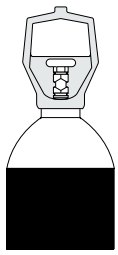

Oxygen



Fixicontrol Ox, 4 Bar HT
331290



Unicontrol 500 Ox, 10 Bar HT
309226
Hexagonal nut
309228



SAFE-GUARD-5 Ox
332142

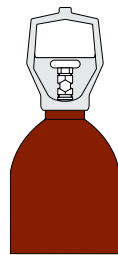

Acetylene



Fixicontrol Ac HT
331291



Unicontrol 500 Ac HT
309257
Hexagonal nut
309227



SAFE-GUARD-5 Ac
332143



Accessories

| | |
|-----------------|--------|
| Gas lighter | 300895 |
| Cleaning needle | 305435 |
| Gas saver GS 10 | 300838 |



Multiple flame heating attachments, Acetylene

| I/h | |
|-------|--------|
| 500 | 300357 |
| 800 | 300359 |
| 1 000 | 300448 |

Multiple Flame heating attachments, Propane

| | |
|------|--------|
| 90 | 300410 |
| 1000 | 300351 |



Accessories

| | |
|--|--------|
| Circle-cutting support for hole diametres Ø 60–600 mm | 300419 |
| Cutting support, graduated | 300414 |
| Support for hole-cutting attachment, hole diametres Ø 20–60 mm | 300406 |



Cutting nozzle HP 433 Propane

| | mm | 2 pcs |
|----------|-------|--------|
| HP 433-1 | 1–3 | 315454 |
| HP 433-2 | 3–8 | 315455 |
| HP 433-3 | 8–20 | 315456 |
| HP 433-4 | 20–50 | 315457 |

Read more about
X11 on page 27



Twin hose 5 m, Ø 5.0 mm with
compression couplings
and non-return valves
307680



BV 12 G 1/4" Non-return valves
Ø 5.0 mm
300386



Handle with non-return valves
BV 12 O 5 mm and clamp coupling
300447



Flexible welding attachments

| l/h | mm | |
|-----|---------|--------|
| 80 | 0.5-1.0 | 300409 |
| 160 | 1.0-2.0 | 300422 |
| 315 | 2.0-4.0 | 300424 |
| 500 | 4.0-6.0 | 300435 |
| 800 | 6.0-9.0 | 300434 |

Double flexible welding attachments

| | | |
|---------|---------|--------|
| 160 x 2 | 1.0-2.0 | 307360 |
|---------|---------|--------|

Flexible welding attachments with hard tip

| | | |
|-----|---------|--------|
| 160 | 1.0-2.0 | 329614 |
| 230 | 2.0-3.0 | 335102 |
| 315 | 3.0-4.0 | 329615 |
| 500 | 4.0-6.0 | 329616 |

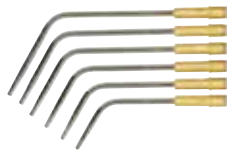

Welding attachments

| l/h | mm | |
|------|----------|--------|
| 40 | 0.2-0.5 | 300388 |
| 80 | 0.5-1.0 | 300390 |
| 160 | 1.0-2.0 | 300392 |
| 230 | 1.5-3.0 | 300402 |
| 315 | 2.0-4.0 | 300394 |
| 400 | 3.5-5.0 | 300368 |
| 500 | 4.0-6.0 | 300396 |
| 650 | 5.0-7.0 | 300391 |
| 800 | 6.0-9.0 | 300398 |
| 1000 | 8.0-12.0 | 300400 |
| 1250 | 9.0-14.0 | 300436 |

Welding



Cutting nozzle HA 411 Acetylene

| | mm | 2 pcs |
|----------|--------|--------|
| HA 411-1 | 1-3 | 315439 |
| HA 411-2 | 3-8 | 315450 |
| HA 411-3 | 8-20 | 315451 |
| HA 411-4 | 20-50 | 315452 |
| HA 411-5 | 50-100 | 315453 |



Cutting attachments

| | |
|---------------------|--------|
| 90° Acetylene lever | 300374 |
| 90° Propane lever | 300373 |

Cutting



X21 Overview.

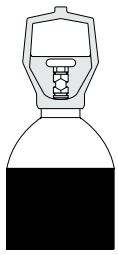

Oxygen



Unicontrol 500 Ox HT
309226
Hexagonal nut
309228



SMOOTHFLO®
ODOROX®/Oxygen
332999



SAFE-GUARD-5 Ox
332142

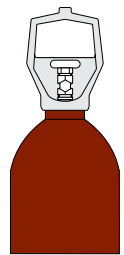

Acetylene



Unicontrol 500 Ac HT
309257
Hexagonal nut
309227



SMOOTHFLO®
Acetylene
333000



SAFE-GUARD-5 Ac
332143



Multiple flame heating attachment – Propane

| I/h | |
|------|--------|
| 1000 | 300494 |
| 2000 | 300493 |
| 4000 | 300491 |
| 7000 | 300489 |

Multiple flame heating attachments – Acetylene

| I/h | |
|------|--------|
| 1000 | 300545 |
| 1800 | 334436 |
| 2500 | 300543 |
| 5000 | 300541 |

Single flame heating attachments – Acetylene

| I/h | |
|------|--------|
| 1800 | 300542 |
| 2500 | 300525 |
| 5000 | 300547 |

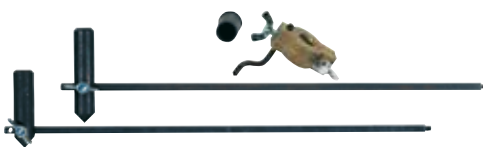

Accessories

| | |
|---|--------|
| Double cutting support, adjustable with small wheels | 300576 |
| Double cutting support with large wheels | 300584 |
| Double cutting support, adjustable with large wheels and graduation | 300510 |
| Cutting support with centre holder for large wheels | 300575 |
| Cutting support with centre holder for small wheels | 300564 |
| Support for hole-cutting attachment 0° (wheel diameter Ø 20–100 mm) | 300572 |
| Spacer sleeve | 300568 |

Cutting nozzle COOLEX® P 311 Propane

| | mm | |
|---------|---------|--------|
| P 331-1 | 1–3 | 300675 |
| P 331-2 | 3–10 | 300676 |
| P 331-3 | 10–25 | 300668 |
| P 331-4 | 25–50 | 300674 |
| P 331-5 | 50–100 | 300671 |
| P 331-6 | 100–200 | 300670 |
| P 331-7 | 200–300 | 300669 |
| P 331-8 | 300–500 | 300672 |

Read more about
X21 on page 34



Twin hose 10 m
with hose couplings
Ø 6.3 mm
305034



BV 12 G 3/8" Non-return valves
Ø 6.3 x 6.3 mm
300522
Ø 8.0 x 8.0 mm
300553



X21 Handle with
non-return valve BV 12 O 6.3
Round
300581
Oval
308543



Welding

Flexible welding attachments

| l/h | mm | |
|-----|---------|--------|
| 160 | 1.0-2.0 | 300583 |
| 315 | 2.0-4.0 | 300600 |
| 500 | 4.0-6.0 | 300599 |

Welding attachments

| l/h | mm | |
|------|----------|--------|
| 40 | 0.2-0.5 | 300578 |
| 80 | 0.5-1.0 | 300582 |
| 160 | 1.0-2.0 | 300596 |
| 230 | 2.0-3.0 | 300605 |
| 315 | 2.0-4.0 | 300604 |
| 400 | 3.5-5.0 | 300603 |
| 500 | 4.0-6.0 | 300590 |
| 650 | 5.0-7.0 | 300594 |
| 800 | 6.0-9.0 | 300470 |
| 1000 | 7.0-10.0 | 300459 |
| 1250 | 9.0-14.0 | 300460 |



Cutting

Cutting nozzle HA 311 Acetylene

| | mm | |
|----------|---------|--------|
| HA 311-1 | 1-3 | 305847 |
| HA 311-2 | 3-10 | 305853 |
| HA 311-3 | 10-25 | 305849 |
| HA 311-4 | 25-50 | 305852 |
| HA 311-5 | 50-100 | 305834 |
| HA 311-6 | 100-200 | 305843 |
| HA 311-7 | 200-300 | 305841 |
| HA 311-8 | 300-500 | 305832 |

Cutting attachments

| | | |
|-----|-------|--------|
| 0° | lever | 300487 |
| 45° | lever | 300554 |
| 75° | lever | 300500 |
| 90° | lever | 300569 |



MIG/MAG and TIG Welding – Overview.



PROSAVER® Regulator
Argon and MISON®
331001



PROSAVER® Double Flow
332331



Unicontrol 100 HT
Argon and MISON®
309260



Fits only to Unicontrol 100HT
Rotam Plus for Unicontrol
Single 300100
T-piece 300104



Unicontrol 300 HT
Argon and MISON®
309252



SMOOTHFLO®
MISON®/Argon
333843



Fixicontrol
Argon and MISON® HT
331292



Dry flow – Argon hose
Ø 5.0 mm, 10 or 50 metre
334496
Ø 6.3 mm, 10 or 50 metre
334498

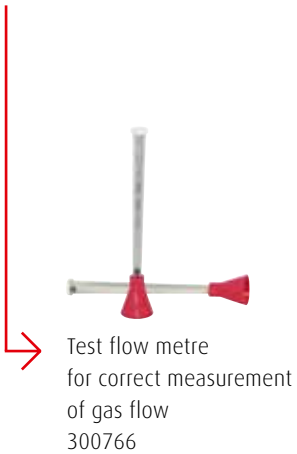

Test flow metre
for correct measurement
of gas flow
300766



PROSAVER®
GS40
adjustable
336322

PROSAVER®
GS40
fixed
336323



Gas pre-heater
for large gas outlets
in a cold environment
CO₂
309450

Toolboxes.

AGA offer assorted toolboxes of welding equipment, where selected and most common components have been put together.

A further step has now been taken in toolbox development. You should only pay for what you really need and so we have developed new toolboxes based on individual user needs.

The toolboxes are easy to use and easy to carry around for example when working in a mobile setting.

X21 Torch system.

X21 PRO.

336009



X11 Torch system.

X11 PRO.

334329



X11 Torch system.

X11 PRO PLUS.

334431



X21 Torch system.

X21 PRO PLUS.

336119



X11 Torch system.

X11 PRO FLEX.

334434



X21 Torch system.

X21 PROPANE.

336008



X11 Torch system.

X11 COMBI.

310133



X21 Torch system.

X21 COMBI.

316161



X11 Torch system.

FLAME® kit.

Incl. 5 l cylinders

323078

Excl. cylinders

334168



AGA Regulators.

Properties that characterise AGA regulators:

- Adapted to and meet the requirements stipulated by the EN ISO 2503 standard
- The regulator housing must be marked in accordance with the applicable standard
- Approved in an oxygen shock test conducted by an independent testing institute
- A filter within the regulator prevents particles from entering the seat



SMOOTHFLO® Regulators.



The SMOOTHFLO® gas pressure regulator represents the highest level of development in the global arena. Incorporating several patented world firsts, SMOOTHFLO® combines the best current regulator features with new customer-led innovative developments, making it one of the easiest products to use on the market. Manufactured and certified to ISO 2503 and AS 4267 and TUV approved, SMOOTHFLO® provides maximum regulator safety.

Features

- Patented technology enables multi-stage type performance from a single-stage regulator
- Pressure adjusting knob mechanism that allows the maximum setting to be reached in less than three turns
- Break-off inlet stem – in the event that the regulator and connected cylinder are impacted by a fall, not only will the inlet stem break off to protect the regulator, but a high-performing excess-flow valve will automatically safely seal off gas discharge from the cylinder into the atmosphere
- Protective cladding – fabricated from impact resistant material. Splash and dust resistance ensures light and low maintenance

| SMOOTHFLO® | Work area (bar) | Content pressure gauge (bar) | Work pressure gauge (bar) | Connection | | | Part no. |
|----------------|-----------------|------------------------------|---------------------------|---------------|--------|-----------|----------|
| | | | | Inlet | Thread | Outlet | |
| Acetylen | 0-1.5 | 0-40 | 0-2.2 | G 3/4" | Ext. | G 3/8" LH | 333000 |
| ODOROX®/Oxygen | 0-10 | 0-230 | 0-16 | W 21.8 x 1/4" | Int. | G 3/8" | 332999 |

SMOOTHFLO® Acetylene

— 25 bar — 15 bar — 4 bar

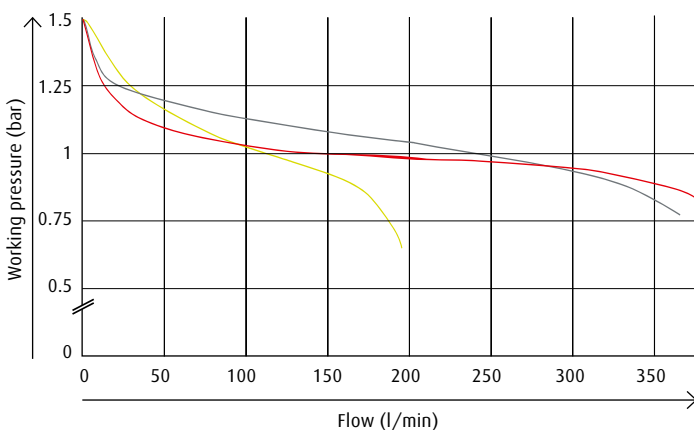

SMOOTHFLO® Oxygen

— 200 bar — 100 bar — 50 bar — 21 bar

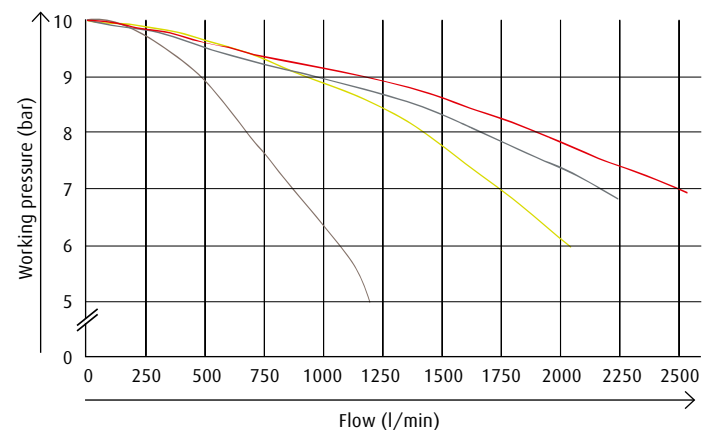

Unicontrol 500.



309257



309226



309227



309228

Unicontrol 500 is suitable for the majority of industrial gases and can cope with all gas welding, heating and soldering, as well as the gas cutting of materials up to a thickness of 300 mm.

Features

- Unicontrol 500 is available in handtight or with hexagon nut
- Stable working flow and outlet pressure in the whole working area. Suitable for X11 and X21
- Unicontrol 500 has easy-to-read pressure gauges and single wheel adjustment of the working pressure

Supplied with hose fittings for \varnothing 5.0 and 6.3 mm hose diametres, cap nuts and 3 extra O-rings or gaskets.

| Unicontrol 500 | | | | | | | |
|-------------------------|-----------------|------------------------------|---------------------------|-----------------------------------|--------|----------------------|----------|
| | Work area (bar) | Content pressure gauge (bar) | Work pressure gauge (bar) | Connection Inlet | Thread | Outlet | Part no. |
| HT nut* | | | | | | | |
| Acetylene | 0-1.5 | 0-40 | 0-2.5 | G $\frac{3}{4}$ " | Ext. | G $\frac{3}{8}$ " LH | 309257 |
| Oxygen | 0-10.0 | 0-315 | 0-16.0 | W 21.8 x $\frac{1}{4}$ " | Int. | G $\frac{3}{8}$ " | 309226 |
| Hexagonal nut | | | | | | | |
| Acetylene | 0-1.5 | 0-40 | 0-2.5 | G $\frac{3}{4}$ " | Ext. | G $\frac{3}{8}$ " LH | 309227 |
| Oxygen | 0-10.0 | 0-315 | 0-16.0 | W 21.8 x $\frac{1}{4}$ " | Int. | G $\frac{3}{8}$ " | 309228 |
| Argon, Nitrogen, Helium | 0-10.0 | 0-315 | 0-16.0 | W 24.32 x $\frac{1}{4}$ " | Int. | G $\frac{3}{8}$ " | 309254 |
| Nitrogen | 0-2.0 | 0-315 | 0-6.0 | W 24.32 x $\frac{1}{4}$ " | Int. | G $\frac{3}{8}$ " | 309250 |
| Carbon dioxide | 0-10.0 | 0-315 | 0-16.0 | W 21.8 x $\frac{1}{4}$ " | Int. | G $\frac{3}{8}$ " | 309253 |
| Air | 0-10.0 | 0-315 | 0-16.0 | G $\frac{5}{8}$ " | Ext. | G $\frac{3}{8}$ " | 309256 |
| Hydrogen | 0-10.0 | 0-315 | 0-16.0 | W 21.8 x $\frac{1}{4}$ " LH | Int. | G $\frac{3}{8}$ " LH | 309255 |
| Propane | 0-2.5 | - | 0-6.0 | (NGO) 0.885" x $\frac{1}{4}$ " LH | Ext. | G $\frac{3}{8}$ " LH | 309229 |

* Handtight connection

Acetylene

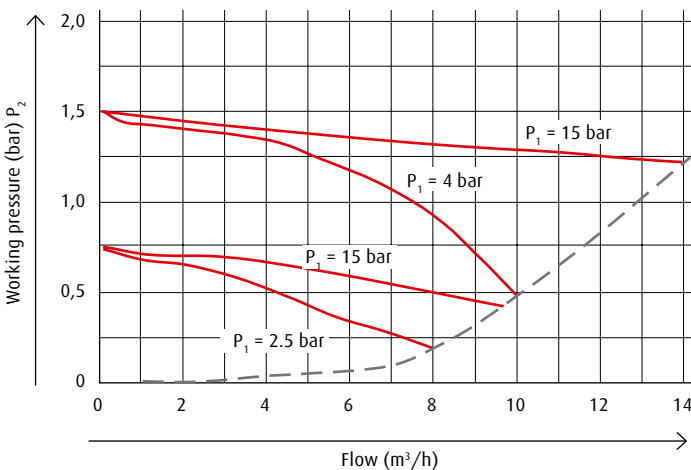

Oxygen

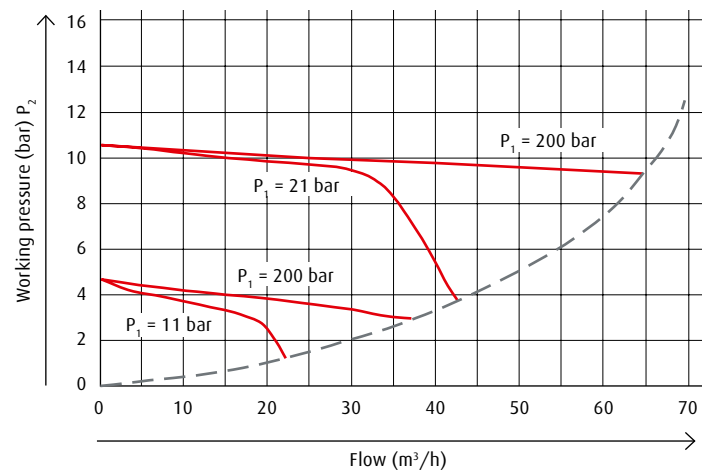

The flow rate curve shows the change in working pressure in relation to the flow outlet.

Fixicontrol Handtight.



Fixicontrol HT is intended for small- to medium-sized gas outlets and copes with all gas welding, soldering, heating with nozzles max. 2.500 l/h and gas cutting of materials up to a thickness of 50 mm. The regulator has a handtight connection and is therefore very well-suited to small equipment that is frequently transported.

Features

- Fixicontrol HT is available for acetylene and oxygen. It comes with easy-to-read pressure gauges fitted with rubber protection
- Single wheel adjustment of the working pressure for straightforward usability
- Fixicontrol is suitable with X11

Supplied with pressure gauge protection, hose fitting for gas hose \varnothing 5.0 mm, cap nut and 3 extra O-rings.

| | Work area (bar) | Content pressure gauge (bar) | Work pressure gauge (bar) | Connection | | | Part no. |
|-----------|-----------------|------------------------------|---------------------------|--------------------------|--------|----------------------|----------|
| | | | | Inlet | Thread | Outlet | |
| Acetylene | 0-1.5 | 0-40 | 0-2.5 | G $\frac{3}{4}$ " | Ext. | LH G $\frac{3}{8}$ " | 331291 |
| Oxygen | 0-4.0 | 0-315 | 0-6.0 | W 21.8 x $\frac{1}{4}$ " | Int. | RH G $\frac{3}{8}$ " | 331290 |

Acetylene

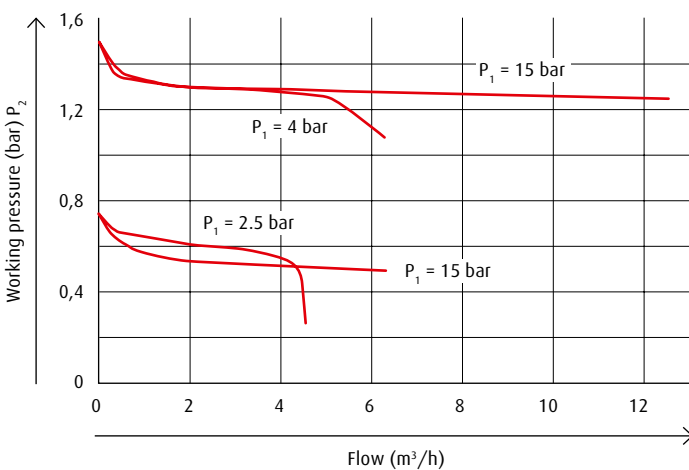

Oxygen

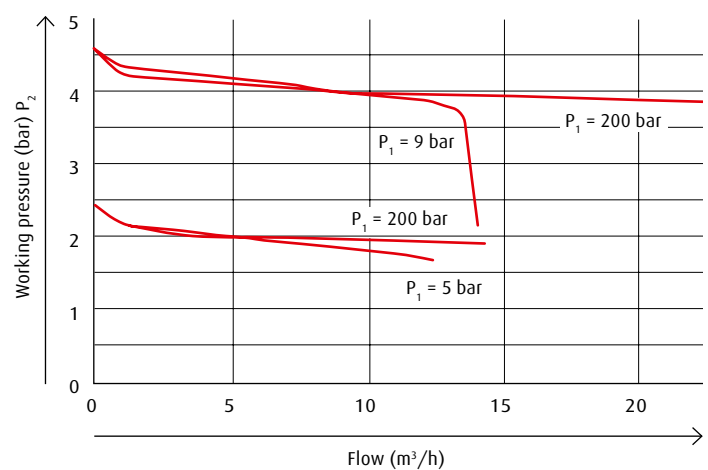

The flow rate curve shows the change in working pressure in relation to the flow outlet.

AGA PRO 200/300.

The AGA PRO regulator series consists of premium cylinder regulators with high performance capacity, durability and quality. Due to their unique construction and technology, the regulators keep continuous pressure even with variations in cylinder pressure, which is an outstanding advantage for the user.

The PRO regulators are produced for a very wide range of industrial gases and specific pressure ranges. AGA PRO is intended for use with medium and high consumption of gas. The outlet is delivered with hose nipple 6.3 mm. Regulators for working pressure of more than 10 bar are delivered with 12 mm brazing nipple on outlet.

The unique and stable construction, combined with precise quality control, gives a product that is both long-lasting and reliable. The regulators are produced according to EN 2503 for safe handling of compressed gases. Oxy-fuel processes, welding and pressure testing are standard applications for AGA PRO. Suitable also for applications within high flow when bundle, such as in offshore, construction or building.



Features

- Available in 300 bar with handtight connection
- Constant outlet pressure regardless of cylinder pressure
- High flame stability at high gas outlets and with long hoses
- Precise and stable welding/cutting flame saves time and increases productivity

| 200 bar – Up to 10 bar | | | | | | | |
|---|-----------------|------------------------------|---------------------------|---------------------|--------|-----------|----------|
| | Work area (bar) | Content pressure gauge (bar) | Work pressure gauge (bar) | Connection Inlet | Thread | Outlet | Part no. |
| Acetylene | 0–1.5 | 0–40 | 0–2.5 | G 3/4" | Ext. | G 3/8" LH | 333219 |
| Oxygen | 0–10 | 0–315 | 0–16 | W 21.80 x 1/4" RH | Int. | G 3/8" | 333231 |
| Nitrogen | 0–10 | 0–315 | 0–16 | W 24.32 x 1/4" RH | Int. | G 3/8" | 333227 |
| Air | 0–10 | 0–315 | 0–16 | G 5/8" RH | Ext. | G 3/8" | 333230 |
| Hydrogen | 0–10 | 0–315 | 0–16 | W 21.80 x 1/4" LH | Int. | R 3/8" LH | 333237 |
| Carbon dioxide | 0–10 | 0–315 | 0–16 | W 21.80 x 1/4" RH | Int. | G 3/8" | 333236 |
| Argon/MISON® | 0–10 | 0–315 | 0–16 | W 24.32 x 1/4" RH | Int. | G 3/8" | 333235 |
| Oxygen | 0–1 | 0–315 | 0–2.5 | W 21.80 x 1/4" RH | Int. | G 3/8" | 333221 |
| Nitrogen | 0–1 | 0–315 | 0–2.5 | W 24.32 x 1/4" RH | Int. | G 3/8" | 333218 |
| THERMOLEN® | 0–4 | 0–25 | 0–6.0 | W 21.80 x 1/4" LH | Ext. | G 3/8" LH | 333226 |
| Propane | 0–10 | 0–25 | 0–16 | (NGO) 0.885" x 1/4" | Ext. | G 3/8" LH | 333220 |
| Argon/MISON® | 0–24 L/min | 0–315 | 0–28 L/min | W 24.32 x 1/4" RH | Int. | G 3/8" | 333234 |
| Argon/MISON® | 1 x 0–24 L/min | 0–315 | 1 x 0–30 L/min | W 24.32 x 1/4" RH | Int. | G 3/8" | 333222 |
| Argon/MISON® | 2 x 0–24 L/min | 0–315 | 2 x 0–30 L/min | W 24.32 x 1/4" RH | Int. | G 3/8" | 333229 |
| Carbon dioxide | 0–1 | 0–315 | 0–2.5 | W 21.80 x 1/4" RH | Int. | G 3/8" | 333240 |
| Air, Special design without hand wheel | 0–12 | 0–315 | 0–16 | G 5/8" RH | Ext. | G 3/8" | 333242 |
| 200 bar – over 10 bar (note: A high pressure hose must be used to the outlet) | | | | | | | |
| Nitrogen | 0–28 | 0–315 | 0–40 | W 24.32 x 1/4" RH | Int. | G 3/8" | 333239 |
| Oxygen | 0–28 | 0–315 | 0–40 | W 21.80 x 1/4" RH | Int. | G 3/8" | 333216 |
| Nitrogen | 0–40 | 0–315 | 0–60 | W 24.32 x 1/4" RH | Int. | G 3/8" | 333217 |
| Oxygen | 0–200 | 0–315 | 0–315 | W 21.80 x 1/4" RH | Int. | G 3/8" | 333233 |
| Nitrogen | 0–200 | 0–315 | 0–315 | W 24.32 x 1/4" RH | Int. | G 3/8" | 333225 |
| Hydrogen | 0–200 | 0–315 | 0–315 | W 21.80 x 1/4" LH | Int. | G 3/8" LH | 333238 |
| Air | 0–200 | 0–315 | 0–315 | G 5/8" RH | Ext. | G 3/8" | 333223 |
| 300 bar – Handtight connection | | | | | | | |
| Nitrogen | 0–10 | 0–400 | 0–16 | W30 x 2 RH NEVOC | Int. | G 3/8" | 331921 |
| Nitrogen | 0–28 | 0–400 | 0–40 | W30 x 2 RH NEVOC | Int. | G 3/8" | 331922 |
| Nitrogen | 0–100 | 0–400 | 0–315 | W30 x 2 RH NEVOC | Int. | G 3/8" | 331923 |
| Nitrogen | 0–200 | 0–400 | 0–315 | W30 x 2 RH NEVOC | Int. | G 3/8" | 331920 |
| Nitrogen | 0–300 | 0–400 | 0–400 | W30 x 2 RH NEVOC | Int. | G 3/8" | 331959 |

Capacity curve AGA Pro regulator – Oxygen

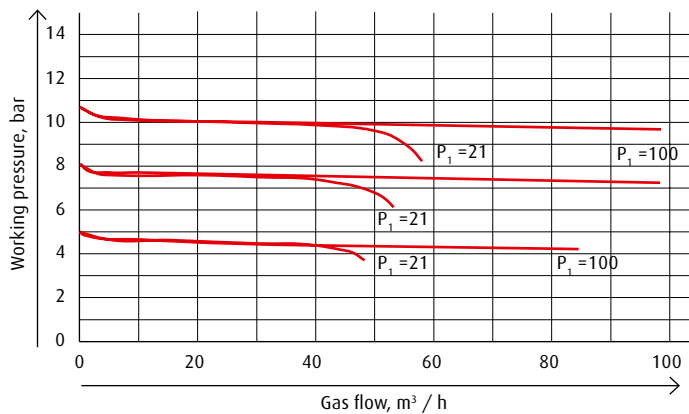

Capacity curve AGA Pro regulator – Acetylene

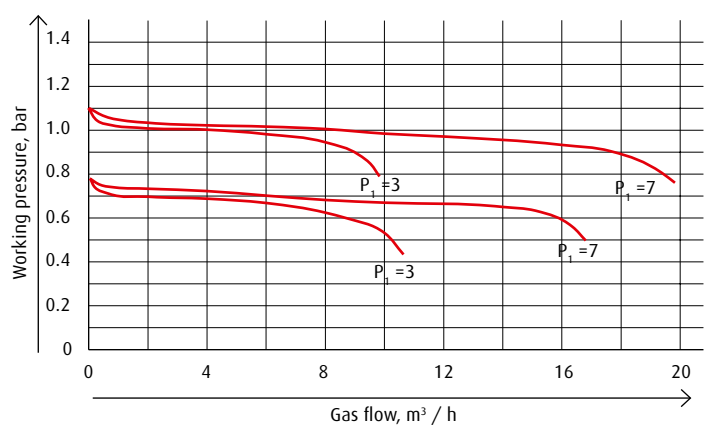

Accessories for Pressure Regulators.

SMOOTHFLO®

| Inlet stem, Nut, Gasket | Qty in SB | Part no. |
|--------------------------|-----------|----------|
| Oxygen SMOOTHFLO® | | 333921 |
| Acetylene SMOOTHFLO® | | 333957 |
| Argon SMOOTHFLO® | | 333958 |
| Outlet adapter | | |
| Oxygen SMOOTHFLO® | | 333959 |
| Acetylene SMOOTHFLO® | | 333943 |
| Argon SMOOTHFLO® | | 333944 |
| Gaskets | | |
| SMOOTHFLO® Oxygen, Argon | 10 | 333962 |
| SMOOTHFLO® Acetylene | 10 | 333922 |

Unicontrol 500 AND 600.

| Content pressure gauge | Qty in SB | Part no. |
|---|-----------|----------|
| Oxygen 0–315 bar | | 300038 |
| Acetylene 0–40 bar | | 300048 |
| Neutral 0–315 bar | | 300047 |
| Working pressure gauge | | |
| Oxygen 0–16 bar | | 300042 |
| Acetylene 0–2.5 bar | | 300046 |
| Neutral 0–16 bar | | 300045 |
| Neutral 0–6 bar | | 300044 |
| Pressure gauge protection | | |
| Pressure gauge protection | | 300192 |
| Gaskets | Part no. | |
| Pressure gauge gasket | | 309524 |
| Acetylene + Oxygen (nylon + aluminium) | 5 + 5 | 300793 |
| Oxygen + carbon dioxide (aluminium) | 100 | 300055 |
| | 10 | 309372 |
| Acetylene (nylon) | 100 | 300054 |
| | 10 | 309373 |
| Argon, air, hydrogen, nitrogen (nylon) | 100 | 300053 |
| | 10 | 300089 |
| O-rings – only for Unicontrol 500 HT | | |
| Acetylene HT | 10 | 300193 |
| Oxygen, Argon HT, MISON® and MISON® mixtures (Unicontrol) | 10 | 308384 |
| Oxygen, Argon HT, MISON® and MISON® mixtures (Jetcontrol) | 10 | 300194 |

Fixicontrol HT.

| Content pressure gauge | Qty in SB | Part no. |
|--|-----------|----------|
| Acetylene | 40 bar | 308265 |
| Oxygen | 315 bar | 308740 |
| Working pressure gauge | | |
| Acetylene | 2.5 bar | 308741 |
| Oxygen | 6 bar | 300223 |
| O-rings | | |
| Acetylene HT | 10 | 300193 |
| Oxygen, Argon HT as well as MISON® and MISON® mixtures | 10 | 308384 |
| Other | | |
| Pressure gauge protection | 1 | 309421 |

AGA PRO 200/300.

| Content pressure gauge | Qty in SB | Part no. |
|---------------------------|-----------|----------|
| Acetylene 0–40 bar | | 305368 |
| Neutral 0–6 bar | | 305370 |
| Neutral 0–40 bar | | 300085 |
| Oxygen 0–315 bar | | 300087 |
| Neutral 0–315 bar | | 300074 |
| Working pressure gauge | | |
| Oxygen 0–16 bar | | 305373 |
| Neutral 0–16 bar | | 305371 |
| Acetylene 0–2,5 bar | | 305372 |
| Neutral 0–28 l/min | | 305367 |
| Nipple for pressure gauge | | |
| G ¼" | | 300249 |
| Gaskets | | |
| Acetylene (nylon) | 10 | 300096 |
| Oxygen and inert gases | 10 | 303616 |
| O-ring AGA PRO 300 bar | 10 | 336292 |

CR 60

| Content pressure gauge | Qty in SB | Part no. |
|--|-----------|----------|
| Oxygen/Argon | 0–315 bar | 300253 |
| Acetylene | 0–40 bar | 300221 |
| Working pressure gauge | | |
| Oxygen/Argon | 0–25 bar | 300181 |
| Acetylene | 0–2,5 bar | 300183 |
| Gaskets | | |
| Oxygen + carbon dioxide (aluminium) | 10 | 309372 |
| Acetylene (nylon) | 10 | 309373 |
| Argon, air, hydrogen, nitrogen (nylon) | 10 | 300089 |



Regulators for Gas Shielded Arc Welding.

The gas supply to the gas shielded arc welding processes TIG, MIG/MAG and plasma is extremely important when it comes to the welding result. In order to satisfy these requirements, pure shielding gas is required in the gas cap, as are the correct gas flow and a certain amount of additional gas when starting welding.

The best results are achieved in the simplest manner with a short gas hose (as a rule, 1–1.5 m is sufficient) along with a small hose diameter, normally \varnothing 5.0 mm. This optimises the volume in which the "gas boost" is built up.

PROSAVER® is a regulator that works with a constant gas flow and produces an adapted working pressure with, technical and economic benefits as a result.

PROSAVER® Regulator.



PROSAVER® Regulator with integrated gas saver function for shielding gas with flow metre.

Features

- Produces an optimal gas flow for MIG/MAG and TIG welding
- Minimises the "gas boost" when starting the welding cycle, which produces savings as regards gas consumption
- Very even flow 3–30 l/min, regardless of the cylinder pressure
- Developed and adapted for MISON® shielding gases. Also works with other argon and argon mixtures

The greatest gas saving is achieved in the event of numerous short welds in a welding cycle. The size of the gas saving is dependent on the welding method, number of starts and stops, etc.

| PROSAVER® | Content pressure gauge (bar) | Flow meter | Connection | | Part no. |
|-----------------------|------------------------------|------------|------------------|---------|----------|
| | | | Inlet | Outlet | |
| PROSAVER® | 0–315 | 3–30 l/min | W 24.32 x 1/4" | G 3/8" | 331001 |
| PROSAVER® double flow | 0–315 | 3–30 l/min | W 24.32 x 1/4" | G 3/8" | 332331 |
| PROSAVER® FORMIER® | 0–315 | 3–30 l/min | W 21.8 x 1/4" LH | LH 3/8" | 332330 |



Pulse welding with AGA PROSAVER®

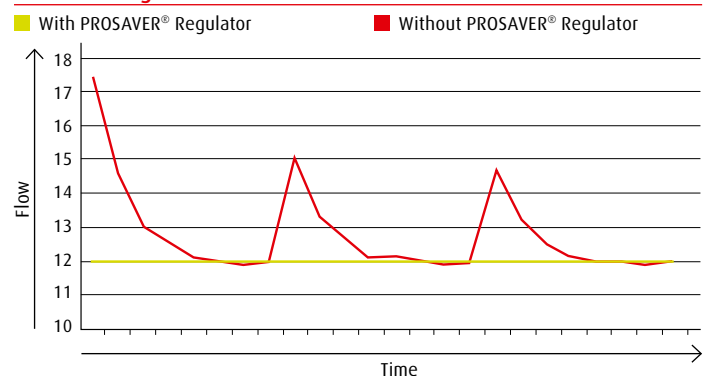

Unicontrol 100 Handtight.

Unicontrol 100 HT is intended for MIG/MAG and TIG welding.

Features

- The regulator is available for MISON® and all mixtures of MISON®, argon and argon mixtures
- It is pre-set at a working pressure of 2.5 bar to produce an accurate flow setting
- Quick and fast installation without using any tools

The flow is read off at the upper edge of the ball/floating device. Supplied with hose fitting for a 5.0 mm hose diameter and 3 extra O-rings.



| Unicontrol 100 Handtight | | | | | | | Part no. |
|--------------------------|------------|------------|----------------|--------|--------|--------|----------|
| Content | Flow meter | Connection | | | | | |
| pressure gauge (bar) | (l/min) | Inlet | Thread | Outlet | | | |
| Argon | 0-315 | 3-32 | W 24.32 x 1/4" | Int. | R 3/8" | 309260 | |

Accessories – Rotam Plus.

Rotam Plus is a flow metre that is used together with argon pressure regulator. The regulator working pressure must be set to 2.5 bar to produce the correct gas flow. Rotam is the suitable product when you have a pressure regulator and want to use it as a flow regulator.

Rotam must be connected to a T-piece, which can be used with one or two Rotams. The T-piece can be adjusted to achieve the correct angle in relation to the regulator's outlet. The T-piece is ordered separately.

The flow is read off at the upper edge of the ball/floating device. Double Rotam is used when shielding gas is required for both a welding gun and root protection. Supplied with a hose fitting for Ø 5.0 mm hose diameter.

Rotam Plus.

| | Part no. |
|-----------------------------|------------|
| Single Rotam Plus | 300100 |
| Double Rotam Plus | 300100 x 2 |
| T-piece incl. blanking plug | 300104 |
| Blanking plug | 301816 |



Spare Parts Kit for Rotam Plus and Unicontrol 100.

| | Flow (l/min) | Max. deviation | Part no. |
|---------------------------------|------------------------|--------------------------|----------|
| | (Working pressure bar) | at various flows (l/min) | |
| Flow metre assembly | | 5/±0.1 | |
| Hexagonal body (Unicontrol 100) | 30 (2.5) | 15/±0.3 | 300195 |
| Round body (Rotam) | 30 (2.5) | 25/±0.5 | 317302 |



SMOOTHFLO® Regulators.

The SMOOTHFLO® gas pressure regulator represents the highest level of development in the global arena.

Features

- Pressure adjusting knob mechanism that allows the maximum setting to be reached in less than three turns
- Break-off inlet stem
- Protective cladding



Supplied with hose fittings for Ø 5.0 and 6.3 mm hose diametres, cap nuts and 3 extra O-rings.

| SMOOTHFLO® | | | | | | | |
|--------------|------------|------------------------------|---------------------|----------------|--------|--------|----------|
| | Work area | Content pressure gauge (bar) | Flow pressure gauge | Connection | | | Part no. |
| | | | | Inlet | Thread | Outlet | |
| MISON®/Argon | 0-45 l/min | 0-230 | 0-55 l/min | W 24.32 x 1/4" | Inv | G 3/8" | 333843 |

Unicontrol 300 Handtight.

Unicontrol 300 HT is available for MISON® Ar and all mixtures of MISON®, argon and argon mixtures, as well as carbon dioxide.

Features

- The regulator has a content pressure gauge and a flow pressure gauge showing the gas flow in litres per minute, as well as single wheel adjustment of the gas flow
- Unicontrol 300 HT is intended for MIG/MAG and TIG welding
- Quick and fast installation without using any tools



Supplied with hose fittings for Ø 5.0 and 6.3 mm hose diametres, cap nuts and 3 extra O-rings.

| Unicontrol 300 Handtight | | | | | | | |
|--------------------------|------------|------------------------------|-----------------------------|----------------|--------|--------|----------|
| | Work area | Content pressure gauge (bar) | Flow pressure gauge (l/min) | Connection | | | Part no. |
| | | | | Inlet | Thread | Outlet | |
| Argon/MISON® | 0-25 l/min | 0-315 | 0-45 | W 24.32 x 1/4" | Int. | G 3/8" | 309252 |
| Carbon dioxide | 0-25 l/min | 0-315 | 0-45 | W 21.8 x 1/4" | Int. | G 3/8" | 309251 |

Fixicontrol Handtight.

Fixicontrol HT is intended for welding with MIG/MAG and TIG.

Features

- Fixicontrol HT is available for MISON® Ar and all mixtures of MISON®, argon and argon mixtures, as well as carbon dioxide
- Quick and fast installation without using any tools



The regulator has a content pressure gauge and rotametre showing the gas flow in litres/min, as well as an ergonomic wheel for regulating the flow.

| Fixicontrol Handtight | | | | | | | |
|-----------------------|------------|------------------------------|-----------------------------|-------------------|--------|--------|----------|
| | Work area | Content pressure gauge (bar) | Flow pressure gauge (l/min) | Connection | | | Part no. |
| | | | | Inlet | Thread | Outlet | |
| Argon | 0-22 l/min | 0-315 | 0-32 | W 24.32 x 1/4" RH | Int. | G 3/8" | 331292 |
| Carbon dioxide | 0-22 l/min | 0-315 | 0-32 | W 21.80 x 1/4" RH | Int. | G 3/8" | 331293 |

Accessories: Regulators for Gas Shielded Arc Welding.

PROSAVER® GS40.

The prosaver GS40 is the leading accessory for shielding gas arc welding as MIG, MAG and TIG welding technologies. With its small and compact design, the GS40 can be installed downstream most common cylinder pressure regulators or outlet point regulators with flow control. GS40 stabilizes flow and optimises shielding gas pressure in the hose during welding process.

GS40 HELPS TO SAVE UP TO 40 % OF YOUR SHIELDING GAS!

The savings with GS40 represents up to 0,5ltr of the shielding gas on each average weld.

How to use it

When you close the gas flow at common pressure regulator during the welding process interruption, the outlet pressure in the connecting hose raises up much above the optimal level (acc. to ISO 2503 up to 30 %). Then the volume of the gas, higher than really needed, is blowing through the system after the welding process starts again by switching on the arc on the welding torch. GS40 minimises amount of such waste gas cumulated in the connecting hose. The optimal, predefined gas flow

is delivered to the welding process during all its phases. Adjustable variant with the handwheel (GS40A) is to be used with regulators with flow-meter, fixed variant (GS40F) with regulators with litrescaled pressure gauge.



| | Max inlet pressure | Inlet-/outlet connection | Part no. |
|---------------------------|--------------------|--------------------------|----------|
| PROSAVER® GS40 adjustable | 30 bar | G 3/8" | 336322 |
| PROSAVER® GS40 fixed | 30 bar | G 3/8" | 336323 |

Test flow metre for Shielding Gases.

Test flow metre for shielding gas welding for argon and argon mixtures.

The measurement tube must be held vertically and directly against the welding gun's nozzle. The flow is read off in the middle of the ball. The measurement range is 5–25 l/min.



| | Part no. |
|-----------------|----------|
| Test flow metre | 309766 |

Gas Preheater.

Gas preheaters are used for large gas outlets of carbon dioxide when the cylinder regulator is significantly cooled.

The preheater has an output of 25 W and is thermostatically controlled at 70°C.

Capacity: Carbon dioxide 1200 l/h
Threaded connection: Carbon dioxide W 21.80 x 1/4"
Electrical connection: 230 V, single phase and 25 W

CE marked EN-61010 and insulation class IP 44. Supplied with 3 m cable and 4 gaskets.



| | Part no. |
|----------------|----------|
| Carbon dioxide | 309450 |

Note!

Gas pre-heaters may not be used with oxygen or flammable gases.



PROSAVER®

| Prosaver® spare parts | Qty in SB | Part no. |
|--------------------------------|-----------|----------|
| O-ring | 10-pack | 308384 |
| Working pressure gauge neutral | 0-315 bar | 331294 |
| Flow metre complete | | 331295 |
| Control wheel | | 331296 |

Unicontrol 100 HT.

| Pressure gauge for Unicontrol 100 HT. | Qty in SB | Part no. |
|--|--------------------|----------|
| Content pressure gauge | Ar/CO ₂ | 309447 |
| Flow metre assembly | Ar/CO ₂ | 300195 |
| O-rings | | |
| Carbon dioxide, argon HT as well as MISON® and MISON® mixtures | 10 | 308384 |

SMOOTHFLO® – MISON®/Argon.

| Inlet stem, nut, gasket | Qty in SB | Part no. |
|--------------------------|-----------|----------|
| Argon SMOOTHFLO® | | 333958 |
| Outlet adapter | | |
| Argon SMOOTHFLO® | | 333944 |
| Gasket | | |
| SMOOTHFLO® oxygen, argon | 10 | 333962 |

Unicontrol 300 HT.

| Pressure gauge for Unicontrol 300 HT. | Qty in SB | Part no. |
|--|------------|----------|
| Content pressure gauge | 315 bar | 300047 |
| Working pressure gauge | 0-45 l/min | 300178 |
| O-rings | | |
| Oxygen, argon HT as well as MISON® and MISON® mixtures | 10 | 308384 |

Fixicontrol HT.

| Pressure gauge for Unicontrol 100 HT. | Qty in SB | Part no. |
|--|--------------------|----------|
| Content pressure gauge | Ar/CO ₂ | 309447 |
| Flow pressure gauge | Ar/CO ₂ | 309448 |
| O-rings | | |
| Carbon dioxide, Argon HT as well as MISON® and MISON® mixtures | 10 | 308384 |
| Pressure gauge protection | | |
| Pressure gauge protection | 1 | 309421 |

Regulators for High Pressure and Flows.



DIN Control Regulator.

DIN Control regulator is an efficient and affordable regulator for leak and pressure testing with nitrogen. Work area 0-30 bar. Note: A high pressure hose must be used at the outlet.



| DIN Control regulator | | | | | | | | |
|-----------------------|-----------------|------------------------------|---------------------------|----------------|--------|--------|-----------|----------|
| | Work area (bar) | Content pressure gauge (bar) | Work pressure gauge (bar) | Inlet | Thread | Outlet | Qty in SB | Part no. |
| Nitrogen | 0-30 | 0-200 | 0-60 | W 24.32 x 1/4" | Inv. | G 1/4" | | 323992 |
| Gaskets | | | | | | | 10 | 300089 |

CR 60.

CR 60 is a regulator for large gas outlets.

Suitable for cutting more than 300 mm and flushing large pipe systems.

Supplied with a 12 mm hose fitting for acetylene and oxygen, 8 mm fitting for Argon/MISON®, as well as 3 extra gaskets.



| CR 60 | | | | | | | |
|--------------|-----------------|------------------------------|-------------------------|----------------|--------|--------|----------|
| | Work area (bar) | Content pressure gauge (bar) | Work pressure gauge bar | Connection | | | Part no. |
| | | | | Inlet | Thread | Outlet | |
| Acetylene | 0–1.5 | 0–30 | 0–5 | G 3/4" | Ext. | R 1" | 300027 |
| Oxygen | 0–15.0 | 0–300 | 0–30 | W 21.8 x 1/4" | Int. | R 1" | 300032 |
| Argon/MISON® | 0–15.0 | 0–300 | 0–30 | W 24.32 x 1/4" | Int. | R 1" | 300022 |

Gaskets see page 17.

Capacity curves – Acetylene

Inlet pressure – $P_1 = \text{bar}$

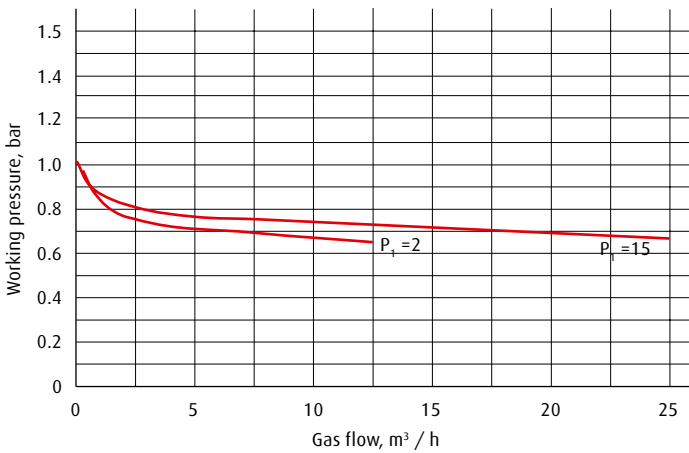

Capacity curves – Oxygen

Inlet pressure – $P_1 = \text{bar}$

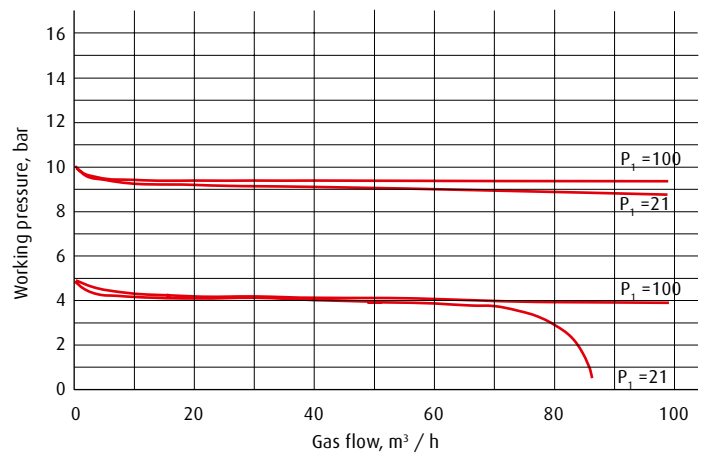

Note!

A high pressure hose must be used at the outlet.

Unicontrol 600.

Unicontrol 600 is a regulator for high working pressure, e.g. pressure testing.

The working pressure is adjusted with a robust regulator screw. When the cylinder pressure is approx. 5 bar above the working pressure, the capacity is approx. 75 m³/h for hydrogen and helium, and approx. 18 m³/h for the other gases. A 1/4" clamping ring connection is supplied, as well as 3 extra gaskets.



| Unicontrol 600 | | | | | | | |
|----------------|-----------------|------------------------------|-------------------------|----------------|--------|-----------|----------|
| | Work area (bar) | Content pressure gauge (bar) | Work pressure gauge bar | Connection | | | Part no. |
| | | | | Inlet | Thread | Outlet | |
| Nitrogen | 0–103 | 0–315 | 0–315 | W 24.32 x 1/4" | Int. | W 21.8 RH | 323191 |
| Nitrogen | 0–200 | 0–315 | 0–315 | W 24.32 x 1/4" | Int. | W 21.8 RH | 300004 |
| Air | 0–200 | 0–315 | 0–315 | G 5/8" | Int. | W 21.8 RH | 300005 |
| Oxygen | 0–200 | 0–315 | 0–315 | W 21.8 x 1/4" | Int. | W 21.8 RH | 300026 |

Gaskets see page 17.



Toolboxes.

Gas cutting is the most common thermal cutting process due to its low investment cost and high cut quality. Gas cutting is a very flexible process and easy to use in many different work situations, as it is possible to cut product thickness ranging from 0.5 to 2500 mm. It is also suitable for manual and mechanised cutting. Gas cutting is used almost exclusively for cutting unalloyed and low-alloy steel.

X11 PRO Series.

X11 PRO is a combined gas welding and gas cutting toolbox for manual work. It is designed according to the stringent demands stipulated by the standard EN ISO 5172.

The requirements regarding airtightness, mechanical strength, flashback safety, flame stability and the easy adjustment of the torch are the foundations for the X11 system. This means that X11 PRO is a quality torch that satisfies very strict requirements from users regarding operability and operational reliability.

X11 PRO is one of the world's best-selling torch systems. During the final check prior to delivery, each insert and nozzle is lit and the flame is checked.

Benefits of X11 PRO Series:

- Potential to weld material with a thickness of 14 mm (normally a maximum of 6 mm)
- Cuts up to 100 mm with an injector insert (150 mm with pressure cutting attachment)
- Solders and welds with different heating and welding attachments
- Heat for straightening and heat forming
- Oval, grip-friendly torch handle
- Large range of accessories
- X11 PRO is available for the fuel gases acetylene and propane (LPG). With propane, the torch's use is limited to cutting, soldering and heating

Welding

The welding attachments are entirely forged in copper and chrome-plated for effective heat dissipation and to deflect weld spatter. For weld locations that are difficult to access, there are a range of flexible welding attachments that are not chrome-plated. All welding attachments have replaceable welding nozzles.

Cutting

X11 PRO has several different cutting attachment alternatives:

- Lever valve or wheel valve for cutting oxygen
- Acetylene or propane
- Injector or pressure torch
- Nozzle mount 90° or 0°
- Several different ranges of cutting nozzles

Soldering and heating

In addition to welding attachments, there is a single flame heating attachment and multiple flame heating attachments with shower nozzles.

- Single flame inserts are used when narrow heating zones are sought
- Multiple flame inserts are suitable for most wide heating zones and when the entire workpiece is to be heated up

Welding, soldering and heating small parts and thin sheet metal.

Note!

When propane is used a propane hose must be used. This is important, as acetylene and propane react differently to the material in the hose. More info on page 68.



X11 Overview.



| X11 Overview | | | | | | |
|--|---------|--------------|--------------|-----------|---|---|
| Product | X11 PRO | X11 PRO FLEX | X11 PRO PLUS | X11 COMBI | Flame kit – Country specific Excluding gas cylinders | Flame kit – Country specific Including 5 l gas cylinders |
| Part no. | 334329 | 334434 | 334431 | 310133 | 334168 | 323078 |
| Shank X11 ergonomic | | | X | X | X | X |
| Shank X11 round | X | X | | | | |
| Cutting attachment 90 deg | X | X | X | X | X | X |
| Welding attachment 160 litre X11 | | | X | X | X | X |
| Welding attachment 315 litre X11 | X | | X | X | X | X |
| Welding attachment 500 litre X11 | | | X | | X | X |
| Welding attachment 800 litre X11 | | | X | X | | |
| Flexible welding attachment 160 L | | X | | | | |
| Flexible welding attachment 315 L | | X | | | | |
| Flexible welding attachment hard tip 500 L | | X | | | | |
| Heating attachment 1000 L | X | X | X | | | |
| HA411-2 | X | X | X | X | X | X |
| HA411-3 | | | X | X | X | X |
| Non return valves BV12 (SWE, DEN, NOR) | X | X | X | X | | |
| FLAME® arrestor FR20 (FIN, BALTIC) | X | X | X | X | | |
| Cleaning needles | X | X | X | X | X | X |
| Key | | X | X | X | | |
| Cutting table | X | X | X | X | X | X |
| Clamp coupling to handle | X | X | X | X | X | X |
| Cap nut | X | X | X | X | X | X |
| Washer | X | X | X | | X | X |
| Cutting support | | | X | | | |
| Gas lighter | X | X | X | X | X | X |
| Fixicontrol acetylene | | | | X | X | X |
| Fixicontrol oxygen | | | | X | X | X |
| SAFE-GUARD-5 Acetylene | | | | X | X | X |
| SAFE-GUARD-5 Oxygen | | | | X | X | X |
| Fireglove | | | | X | X | X |
| Yellow card | | | | X | X | X |
| Twin hose 5 metre with bv12 or fr20 | | | | | X | X |
| Twin hose 10 metre 5mm | | | | X | | |
| Welding goggles | | | | X | | |
| Box X11 | | X | X | | | |
| Tool belt | X | | | | | |
| X11 COMBI box | | | | X | | |
| FLAME® trolley including boxes | | | | | X | X |
| X11 instruction | X | X | X | X | X | X |
| Bv 12 instruction | X | X | X | X | X | X |

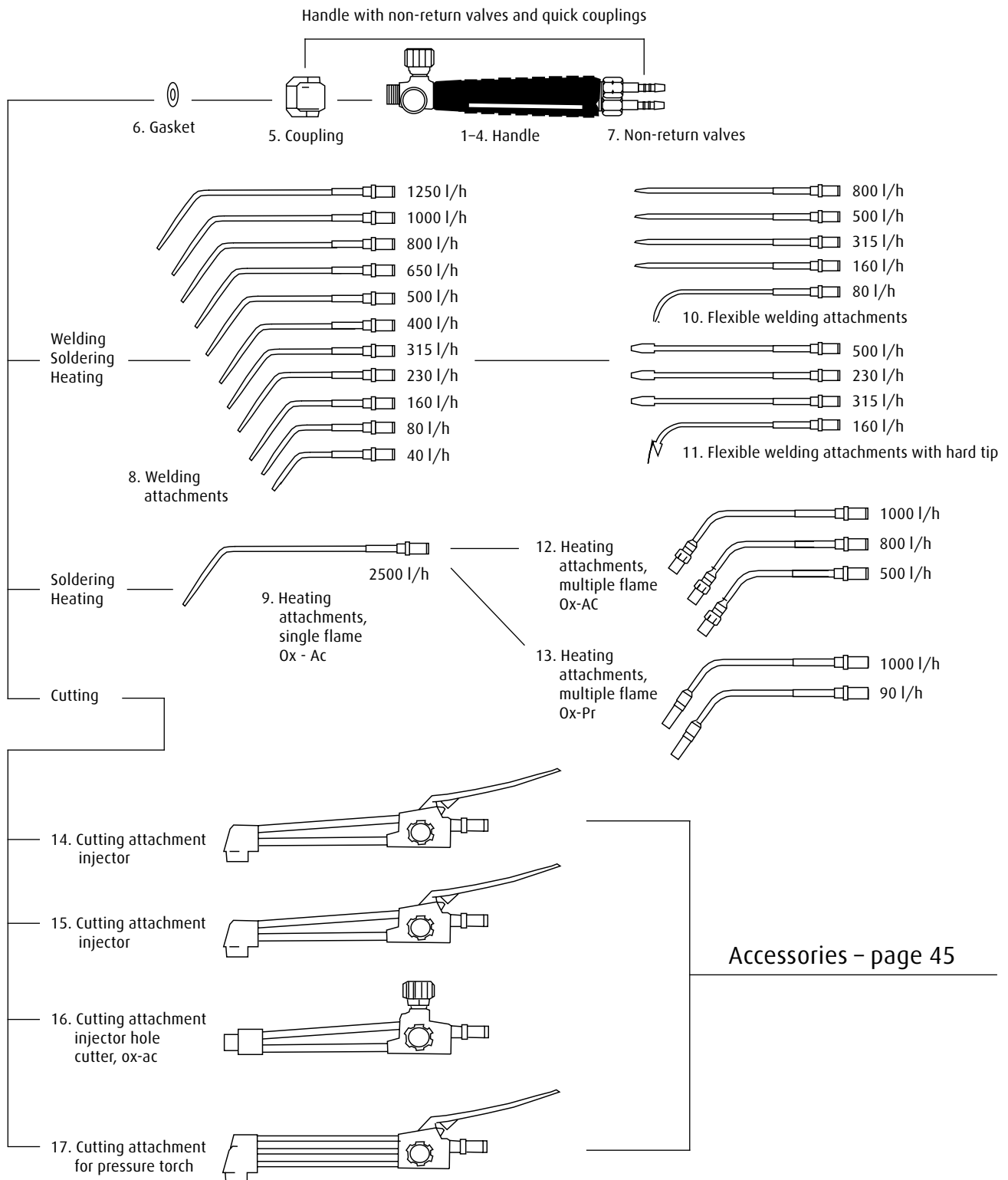

1-6. Handle with Accessories.

| | Qty in SB | Part no. |
|---|-----------|----------|
| 1. Handle ergonomic with non-return valves BV 12 Ø 5.0 mm and clamp coupling | 1 | 300447 |
| 2. Handle round with hose fittings Ø 5.0 mm | 1 | 334437 |
| 3. Handle ergonomic with non-return valves BV 12 Ø 6.3 mm and clamp coupling | 1 | 305421 |
| 4. Handle ergonomic | 1 | 300449 |
| 5. Clamp coupling | 1 | 309170 |
| 6. Gasket for welding and cutting attachment | 10 | 300423 |
| Hose fitting Ø 5.0 mm | 2 | 300834 |
| Cap nut LH G ¼" | | |
| Cap nut G ¼" | 1+1 | 300835 |



7. Non-Return Valve BV 12.

| | Qty in SB | Part no. |
|-------------------------|-----------|----------|
| Ø 5.0 mm ac/pr R ¼" LH | 1+1 | 300386 |
| Ø 5.0 mm Oxygen R ¼" RH | | |
| Ø 6.3 mm ac/pr R ¼" LH | 1+1 | 300442 |
| Ø 6.3 mm Oxygen R ¼" RH | | |



8. Welding Attachments in Accordance with ISO 5172 (DIN 8543).

| Size No. | Gas flow Ox - Ac - Ox l/h | Material thickness mm | Part no. |
|----------|------------------------------|-----------------------|----------|
| 0 | 40 | 0.2-0.5 | 300388 |
| 1A | 80 | 0.5-1.0 | 300390 |
| 2A | 160 | 1.0-2.0 | 300392 |
| E2A | 230 | 1.5-3.0 | 300402 |
| 3A | 315 | 2.0-4.0 | 300394 |
| E3A | 400 | 3.5-5.0 | 300368 |
| 4A | 500 | 4.0-6.0 | 300396 |
| E4A | 650 | 5.0-7.0 | 300391 |
| 5A | 800 | 6.0-9.0 | 300398 |
| E5A | 1000 | 8.0-12.0 | 300400 |
| 6 | 1250 | 9.0-14.0 | 300436 |

Acetylene pressure: 0.1 to 0.8 bar.

Oxygen pressure: 2.5 bar.

| Replaceable welding attachments. | | |
|----------------------------------|------------------------------|----------|
| | Gas flow Ox - Ac - Ox l/h | Part no. |
| | 160 | 300380 |
| | 230 | 300403 |
| | 315 | 300395 |
| | 400 | 300393 |

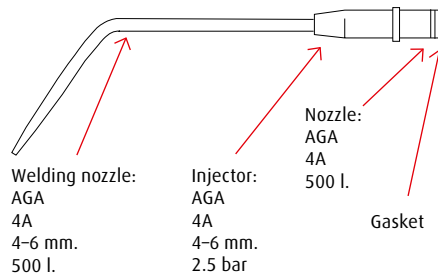
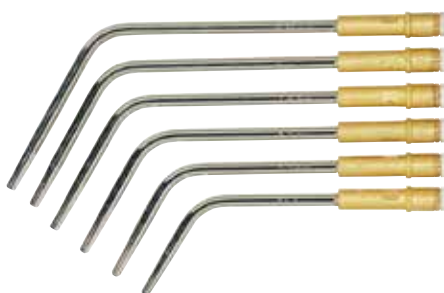

| | |
|---------|---------------------------------------|
| 4 | = Size no. |
| A | = Acetylene |
| 4-6 mm. | = Material thickness |
| 500 l. | = Gas flow, oxygen Litres per hour |
| 2.5 bar | = Working pressure, oxygen |
| i | = Injector torch |
| E | = Extra size in addition to standard |

10. Flexible Welding Attachments.

| Size | Gas flow Ox – Ac – O _x l/h | Material thickness mm | Part no. |
|------|--|-----------------------|----------|
| 1 | 80 | 0.5–1.0 | 300409 |
| 2 | 160 | 1.0–2.0 | 300422 |
| 3 | 160 X 2 | 1.0–2.0 | 307360 |
| 4 | 315 | 2.0–4.0 | 300424 |
| 5 | 500 | 4.0–6.0 | 300435 |
| 6 | 800 | 6.0–9.0 | 300434 |

Acetylene pressure: 0.2–0.6 bar.
Oxygen pressure: 2.5 bar.



11. Flexible Welding Attachments with Hard Tip.

| Size | l/h | Material thickness mm | Part no. |
|------|-----|-----------------------|----------|
| 1 | 160 | 1.0–2.0 | 329614 |
| 2 | 230 | 1.5–3.0 | 335102 |
| 3 | 315 | 2.0–4.0 | 329615 |
| 4 | 500 | 4.0–6.0 | 329616 |

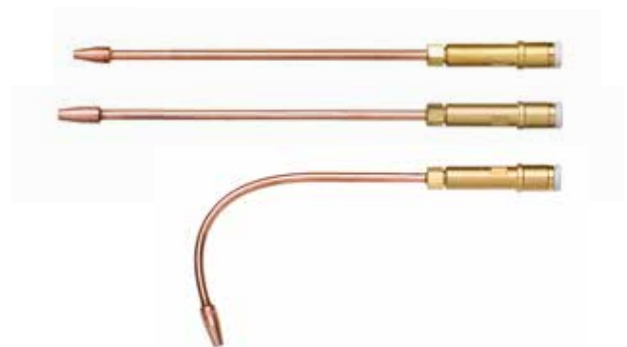

Replaceable Welding Attachments.

| Replaceable flexible welding attachments in table 9 | | |
|---|--|----------|
| | Gas flow Ox – Ac – O _x l/h | Part no. |
| | 315 | 300425 |



9, 12. Heating Attachments for Acetylene.

Acetylene pressure: 0.8 bar
Oxygen pressure: 2.5 bar

Multiple flame heating attachment

Acetylene pressure: 0.6–0.8 bar
Oxygen pressure: 2.5 bar

| 11 – 12. Heating attachments, acetylene. | | |
|--|------------------------|----------|
| Type of heating attachment | Gas flow l/h Oxygen | Part no. |
| 9. Acetylene single flame | 2500 | 309330 |
| 12. Acetylene multiple flame | 500 | 300357 |
| 12. Acetylene multiple flame | 800 | 300359 |
| 12. Acetylene multiple flame | 1000 | 300448 |
| Acetylene, nozzle tip | 500 | 307449 |
| Acetylene, nozzle tip | 800 | 307450 |
| Acetylene, nozzle tip | 1000 | 300431 |



9. Single flame acetylene



12. Multiple flame acetylene

13. Heating Attachments for Propane.

Multiple flame heating attachment propane

Propane pressure: 0.2–0.8 bar

Oxygen pressure: 2.5 bar



| 13. Heating attachments, propane | | |
|----------------------------------|--------------|----------|
| Type of heating attachment | Gas flow l/h | Part no. |
| | Oxygen | |
| 13. Propane multiple flame | 90 | 300410 |
| Propane multiple flame | 1000 | 300351 |

Rule of Thumb for Heating and Straightening.

| Material thickness x 2.5 x 100 = Size heating attachment | Heating output kW Ac/ox flame |
|--|----------------------------------|
| Eg: 7 mm x 2.5 x 100 = 1750 l/h | 20 |
| Eg: 10 mm x 2.5 x 100 = 2500 l/h | 29 |

14–17. Cutting Attachments and Hole-cutting Attachments for Pressure Torch.



300374, Cutting attachment injector, acetylene



300373, Cutting attachment injector, propane



300379, Hole-cutting attachment injector, acetylene



300350, Cutting attachment pressure torch, acetylene or propane

Note!

When using X11 pressure torches and to obtain capacity for cutting 150 mm thick steel, the hose fitting and hose must have a dimension of Ø 6.3 mm.

| 12 – 15. Cutting attachments and hole-cutting attachments for pressure torch | | | | | |
|--|------------------------------|-----------------------------|---------------------|----------------|----------|
| Injector | Length cutting attachment mm | Total length with handle mm | Angle of torch head | Qty in SB pack | Part no. |
| Cutting attachment | | | | | |
| 90° injector oxygen/acetylene with lever | 170 | 350 | 90°HV | 1 | 300374 |
| Cutting attachment | | | | | |
| 90° injector oxygen/propane with lever | 170 | 350 | 90°HV Pr | 1 | 300373 |
| Cutting attachment | | | | | |
| 0° hole cutter injector oxygen/acetylene | 170 | 350 | 0°RV | 1 | 300379 |
| – Nozzle nut for injector torch | | | | 1 | 300432 |
| Pressure torch | | | | | |
| Cutting attachment | | | | | |
| 90° pressure torch with lever | 170 | 350 | 90°HV | 1 | 300350 |
| – Nozzle nut for pressure torch | | | | 1 | 300595 |

HV = Lever for cutting oxygen

Standard Nozzles for X11.

HA 411 – Acetylene.

HA 411 is a flat-sealed 1-piece nozzle with flicker flames.

The nozzle is entirely forged from copper. The gas ducts are cylindrical and produce an even, turbulence-free heating flame and cutting oxygen jet. Note! Nozzle no. 5 for cutting material thickness from 50–100 mm can only be used in X11 equipment manufactured after 1987.



| Cutting data HA 411 | | | | | | | |
|---------------------|--------|-----------|-------------------|----------------|-------------------|----------|-------------------------------|
| | | Acetylene | | Cutting oxygen | | | |
| Serial no. | mm | bar | m ³ /h | bar | m ³ /h | mm/min | Part no. 2 pack 10 pack |
| HA 411-1 | 1–3 | 0.2–0.8 | 0.1–0.2 | 1.5 | 0.2–0.3 | 1200–600 | 315439 300323 |
| HA 411-2 | 3–8 | 0.2–0.8 | 0.1–0.2 | 1.5–2.0 | 0.5–0.6 | 600–500 | 315450 300329 |
| HA 411-3 | 8–20 | 0.2–0.8 | 0.3 | 3.0–4.0 | 1.6–2.0 | 500–320 | 315451 300332 |
| HA 411-4 | 20–50 | 0.2–0.8 | 0.3 | 4.0–4.5 | 3.8–4.2 | 320–200 | 315452 300334 |
| HA 411-5 | 50–100 | 0.2–0.8 | 0.3–0.5 | 3.0–6.5 | 5.0–9.8 | 200–150 | 315453 300336 |

HP 433 – Propane.

HP 433 is a flat-sealed 2-piece nozzle with slotted flames.

The outer nozzle is made of copper and the inner nozzle of brass. The cutting oxygen duct is cylindrical and produces a turbulence-free cutting oxygen jet.



| Cutting data HA 411 | | | | | | | |
|---------------------|-------|---------|-------------------|----------------|-------------------|---------|--------------------|
| | | Propane | | Cutting oxygen | | | |
| Serial no. | mm | bar | m ³ /h | bar | m ³ /h | mm/min | Part no. 2 pack |
| HP 433-1 | 1–3 | 0.3–1.5 | 0.1 | 2 | 0.2–0.3 | 425 | 315454 |
| HP 433-2 | 3–8 | 0.3–1.5 | 0.1–0.2 | 1.5–3.0 | 1.0–1.4 | 485–360 | 315455 |
| HP 433-3 | 8–20 | 0.3–1.5 | 0.3 | 2.0–4.0 | 1.7–3.0 | 380–265 | 315456 |
| HP 433-4 | 20–50 | 0.3–1.5 | 0.3 | 2.5–5.0 | 3.6–6.0 | 310–215 | 315457 |



X21 PRO Series.

The X21 torch system is a complete cutting and welding system with large capacity for several applications such as welding, cutting, heating, soldering, brazing, gouging, flame cleaning and straightening. The X21 can easily be extended to cover each of these specific applications by adding on individual attachments or nozzles suitable for the actual situation.

X21 has been part of the AGA welding equipment portfolio for more than 50 years thanks to its high quality, valued by our customers. The product has developed over the years, but the great performance remains unchanged.

→ Welding capacity up to 14 mm, cutting capacity up to 500 mm

We have now taken yet another step in the development of this toolbox. You should only pay for what you really need. Three toolboxes have been developed based on different types of user needs, which means each toolbox fits its purpose even better.

X21 PRO

This toolbox is designed for you having basic cutting and welding needs. You work in environments like small scrapyards or repair shops where cutting and heating is not in focus in the daily business but you need equipment that is designed for heavy duty work. Equipment in the X21 PRO toolbox is for welding between 2 to 4 mm and cutting between 25 to 50 mm. A 1000 L heating attachment is also included in the box.

X21 PRO PLUS

This toolbox is designed for you working with welding, cutting or heating on regular basis within medium to heavy duty work such as scrapyards, shipyards or other manufacturing industries. Equipment in the X21 PRO PLUS toolbox is for welding between 3,5 to 14 mm and cutting between 3 to 50 mm. Also included in the box is a 1000 L heating attachment and a cutting support.

X21 PROPANE

This toolbox is designed for you who is working with cutting or heating using propane within scrapyards and shipyards. The X21 PROPANE is the first X21 toolbox ever developed for the use of propane as fuel gas.

Equipment in the X21 PROPANE toolbox is for cutting between 10 to 100 mm. A 1000 L heating attachment is also included. Safety has always been AGA's top priority and we always keep our customers in focus. The X21 reflects that by its strong safety focus as well as superior and consistent quality.

By using AGA cutting and welding products you get safety solutions that meet the highest level of safety. This is one way to avoid serious risks when working.

X21 meets all necessary safety requirements and is manufactured according to EN ISO 5172.

X21 Overview.



| X21 Overview | | | | |
|---------------------------------------|---------|--------------|-------------|-----------|
| Product | X21 PRO | X21 PRO PLUS | X21 PROPANE | X21 COMBI |
| Part no. | 336009 | 336119 | 336008 | 316161 |
| Shank X21 Round | x | x | x | x |
| X21 Welding attachment 80 l/h | | | | x |
| X21 Welding attachment 315 l/h | x | | | x |
| X21 Welding attachment 400 l/h | | x | | |
| X21 Welding attachment 500 l/h | | | | x |
| X21 Welding attachment 1250 l/h | | x | | |
| X21 Cutting attachment 90° LEVER | x | x | x | x |
| Cutting nozzle HA 133-2 | | x | | x |
| Cutting nozzle HA 133-3 | | x | | x |
| Cutting nozzle HA 133-4 | | x | | x |
| Cutting nozzle ANME-4 | x | | | |
| Cutting nozzle PNME-3 | | | x | |
| Cutting nozzle PNME-4 | | | x | |
| Cutting nozzle PNME-5 | | | x | |
| Heating attachment 1000 L | x | x | | |
| Heating attachment propane 1000 L | | | x | |
| Non return valves BV12 (SWE, DEN,NOR) | x | x | x | |
| Flame arrestor FR20 (FIN, BALTICS) | x | x | x | |
| Unicontrol 500 HT acetylene | | | | x |
| Unicontrol 500 HT oxygen | | | | x |
| Non-return valve BV-12 acetylene | | | | x |
| Non-return valve BV-12 oxygen | | | | x |
| SAFE-GUARD-5 acetylene | | | | x |
| SAFE-GUARD-5 oxygen | | | | x |
| 5 m twin hose Ø 6.3 mm | | | | x |
| Welding goggles | | | | x |
| Hose clips 4 pcs | | | | x |
| Fire glove | | | | x |
| Cutting support | | x | | |
| Fixed key | x | x | | |
| Cleaning needle kit | x | x | | x |
| Big plastic box | | | | x |
| Welding/cutting table | x | x | | x |
| Instructions | x | x | x | x |

Select the correct nozzle according to the choice of fuel gas

| | |
|-----------|-------------------------|
| Acetylene | HA-311 or COOLEX® A-311 |
| Propane | COOLEX® P-331 |

Note!

When propane is used, a propane hose must be used. This is important, as acetylene and propane react differently to the material in the hose. See page 68.

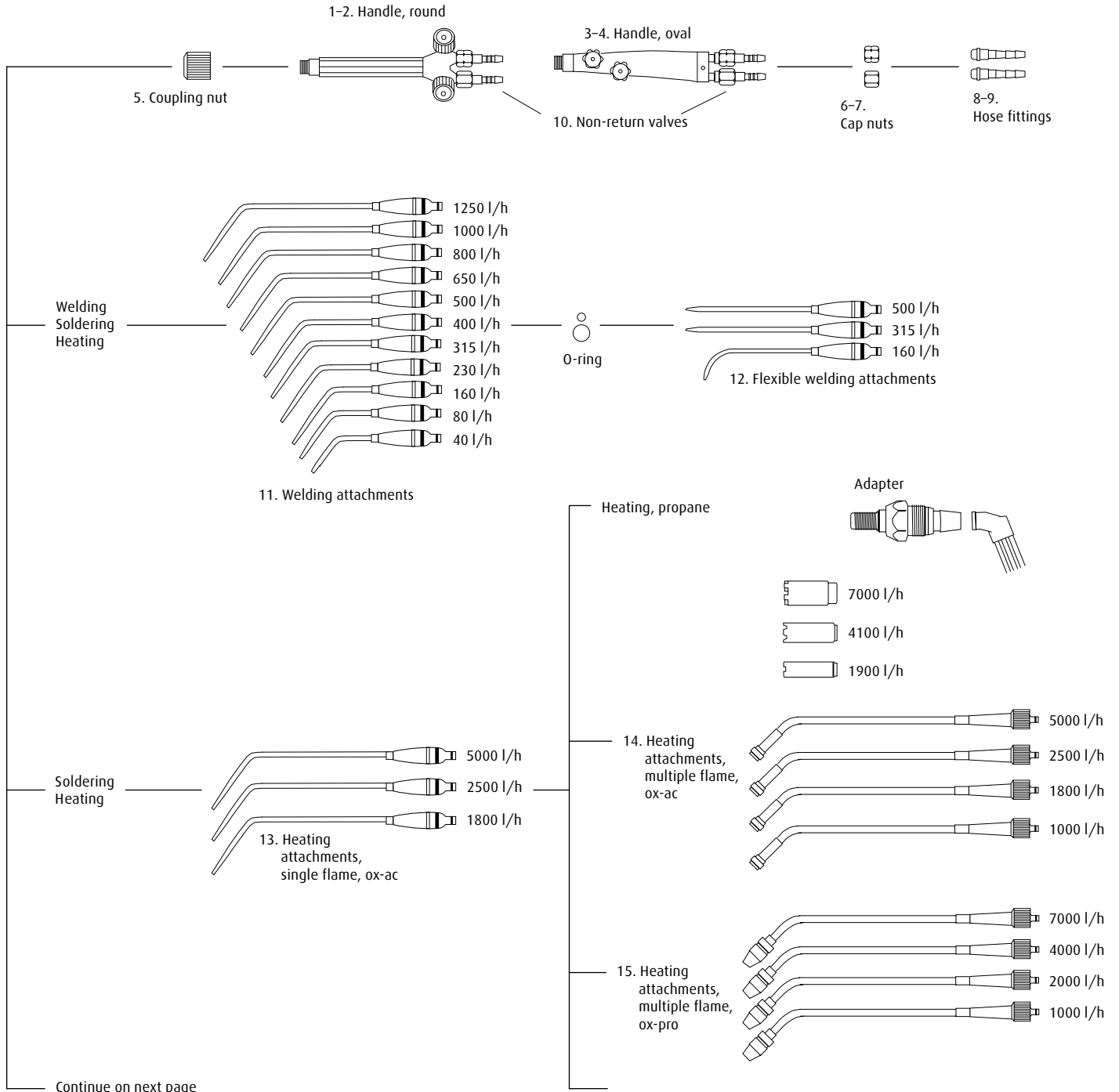

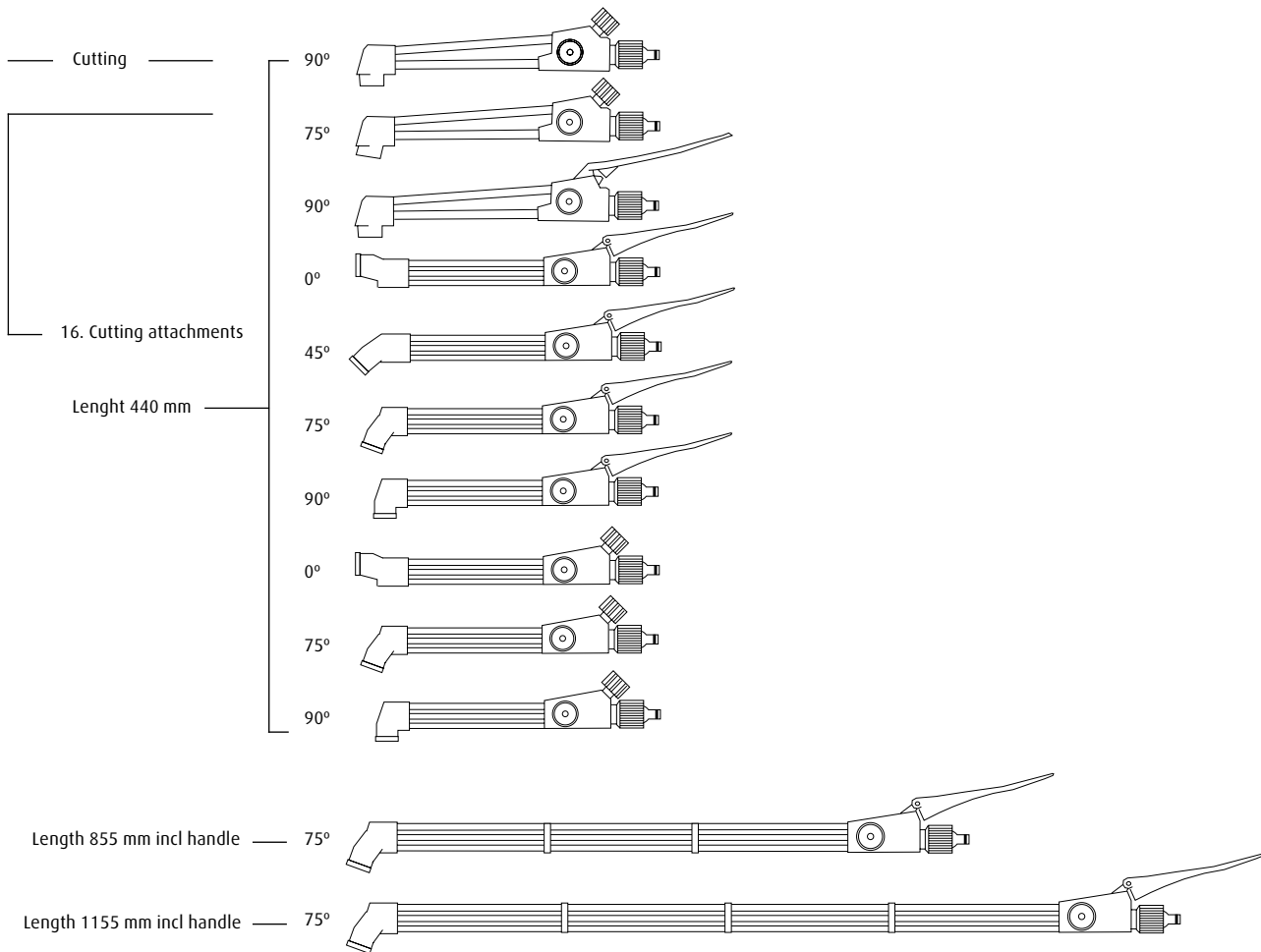

1–9. Handle Welding Attachments.

| 1 – 9. Handle and accessories | | |
|--|----------------|----------|
| | Qty in SB pack | Part no. |
| 1. Handle, round with non-return valve BV 12 Ø 6.3 | 1 | 300581 |
| 2. Handle, round with hose fittings 6.3 mm | 1 | 300527 |
| 3. Handle, oval with non-return BV 12 Ø 6.3 | 1 | 308543 |
| 4. Handle, oval without hose fitting | 1 | 308544 |
| 5. Coupling nut | 1 | 300532 |
| 6. Cap nut LH G 3/8" | 1+1 | 300836 |
| 7. Cap nut G 3/8" RH | | |
| 8. Hose fitting Ø 6.3 mm | 2 | 300931 |
| 9. Hose fitting Ø 8 mm | 2 | 300933 |



Handle, round



Handle, oval

10. Non-Return Valves BV 12 Incl. Hose Couplings.

| 10. Non-return valves BV 12 incl. hose couplings | | |
|--|----------------|----------|
| | Qty in SB pack | Part no. |
| Ø 6.3 mm acetylene/propane | 1+1 | 300522 |
| Ø 6.3 mm oxygen | | |
| Ø 8.0 mm acetylene/propane | 1+1 | 300553 |
| Ø 8.0 mm oxygen | | |
| Ø 10.0 mm acetylene/propane | 1 | 305656 |
| Ø 10.0 mm oxygen | 1 | 305657 |



11. Welding Attachments.

| 11. Welding attachments | | | |
|-------------------------|------------------------|--------------------------|----------|
| Size No. | Gas flow Oxygen l/h | Material thickness mm | Part no. |
| 0 | 40 | 0.2–0.5 | 300578 |
| 1 | 80 | 0.5–1.0 | 300582 |
| 2 | 160 | 1.0–2.0 | 300596 |
| 2E | 230 | 2.0–3.0 | 300605 |
| 3 | 315 | 2.0–4.0 | 300604 |
| 3E | 400 | 3.5–5.0 | 300603 |
| 4 | 500 | 4.0–6.0 | 300590 |
| 4E | 650 | 5.0–7.0 | 300594 |
| 5 | 800 | 6.0–9.0 | 300470 |
| 5E | 1000 | 7.0–10.0 | 300459 |
| 6 | 1250 | 9.0–14.0 | 300460 |

Acetylene pressure: 0.3 bar – Oxygen pressure: 2–6 bar – Proposed outlet pressure



12. Flexible Welding Attachments.

| 12. Flexible welding attachments | | | |
|----------------------------------|------------------------|--------------------------|----------|
| Size No. | Gas flow Oxygen l/h | Material thickness mm | Part no. |
| 1 | 160 | 1.0–2.0 | 300583 |
| 2 | 315 | 2.0–4.0 | 300600 |
| 3 | 500 | 4.0–6.0 | 300599 |

Acetylene pressure: 0.3 bar – Oxygen pressure: 3 bar – Proposed outlet pressure

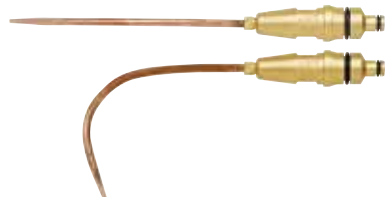

Replaceable Attachments in Accordance with Tables 11 and 12.

| Welding attachments | | |
|--|---|----------|
| A. Nozzles for the welding attachments in table 11 | Gas flow | Part no. |
| | Oxygen l/h | |
| | 160 | 300380 |
| | 230 | 300403 |
| | 315 | 300395 |
| | 400 | 300393 |
| | 500 | 300397 |
| | B. Nozzles for the flexible welding attachments in table 12 | |
| | 160 | 300420 |
| | 315 | 300425 |
| | 500 | 300426 |



O-rings.

| O-rings | | Part no. |
|--------------------------------|--|----------|
| Large O-ring, 10 pack | | 300498 |
| Small O-ring, 10 pack | | 300571 |
| O-ring set 2 small and 2 large | | 300501 |

O-Ring small only for cutting attachment, pressure torch 10 pack Part no. 300570



13. Single Flame Heating Attachments – Acetylene.

| 13. Single flame heating attachments – Acetylene | | | | | | | |
|--|-----------|----------------------|-----------|-----------------|-----------|------------------|----------|
| Size l/h | Length mm | Working pressure bar | | Consumption l/h | | Heating power kW | Part no. |
| | | Oxygen | Acetylene | Oxygen | Acetylene | | |
| 1 800 | 340 | 3 | 0.3 | 1 800 | 1 620 | 21 | 300542 |
| 2 500 | 350 | 6 | 0.4 | 2 500 | 2 250 | 29 | 300525 |
| 5 000 | 510 | 8 | 0.6 | 5 000 | 4 500 | 58 | 300547 |

14. Heating Attachments – Acetylene.

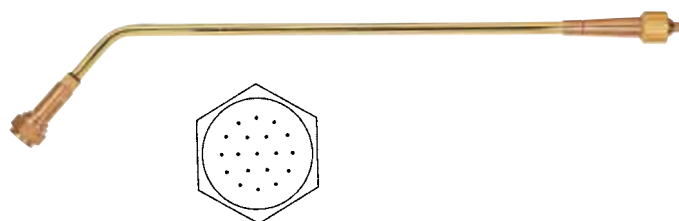

| 14. Heating attachments acetylene – oxygen | | | | | | | |
|--|-----------|----------------------|-----------|-----------------|-----------|------------------|----------|
| Size l/h | Length mm | Working pressure bar | | Consumption l/h | | Heating power kW | Part no. |
| | | Oxygen | Acetylene | Oxygen | Acetylene | | |
| 1 000 | 250 | 3 | 0.3 | 1 000 | 900 | 11.6 | 300545 |
| 1 800 | 400 | 5 | 0.3 | 1 800 | 1 660 | 27.0 | 334436 |
| 2 500 | 670 | 6 | 0.4 | 2 500 | 2 250 | 29.0 | 300543 |
| 5 000 | 680 | 8 | 0.6 | 5 000 | 4 500 | 58.1 | 300541 |

15. Heating Attachments – Propane.



| 15. Heating attachments propane - oxygen | | | | | | | | |
|--|-----------|----------------------|---------|-------------|-------------|-------------|------------------|----------|
| Size l/h | Length mm | Working pressure bar | | Consumption | | | Heating power kW | Part no. |
| | | Oxygen | Propane | Oxygen l/h | Propane l/h | Propane g/h | | |
| 1 000 | 370 | 0.9 | 0.7 | 4 250 | 1 000 | 1 820 | 7 | 300494 |
| 2 000 | 500 | 2.4 | 0.8 | 8 500 | 2 000 | 3 640 | 13 | 300493 |
| 4 000 | 670 | 4.9 | 1.9 | 15 000 | 4 000 | 6 800 | 26 | 300491 |
| 7 000 | 770 | 8.0 | 2.5 | 30 000 | 7 000 | 12 740 | 46 | 300489 |

| Recommendation for straightening | | |
|----------------------------------|--------------------------------|-----------|
| Material thickness x 2.5 x 100 = | Capacity of heating attachment | |
| E.g. material thickness | 7 mm x 2.5 x 100 = | 1.750 l/h |
| | 10 mm x 2.5 x 100 = | 2.500 l/h |
| | 20 mm x 2.5 x 100 = | 5.000 l/h |
| | 25 mm x 2.5 x 100 = | 6.250 l/h |
| | 30 mm x 2.5 x 100 = | 7.500 l/h |

Heating Adapter for X21.

The heating adapter for the X21 is a device for heating with an X21 pressure cutting attachment.

One of the most flexible and essential items in any workshop is gas, along with welding and cutting tools. However, not everyone is aware that welding and cutting are only some of the possibilities offered by such equipment. By adding a few, simple components, the X21 can be used for many different heating processes. The adapter is fitted directly to the torch head on the cutting attachment. The heating nozzle is screwed into the adapter by hand.



| Nozzle | Propane, bar | Oxygen, bar | Propane, l/h | Oxygen, l/h | Heat output, kW | Part no. |
|---------|--------------|-------------|--------------|-------------|-----------------|----------|
| 1H | 0.15-0.5 | 0.7-2.0 | 830-1900 | 3500-7300 | 21.1-47.8 | 309335 |
| 3H | 0.3-1.1 | 1.8-5.0 | 2100-4100 | 8300-16500 | 53.6-105.8 | 309334 |
| 5H | 0.85-2.0 | 3.5-8.7 | 3200-7000 | 12700-28000 | 82.3-181.1 | 309333 |
| Adapter | | | | | | 309336 |

The heat output varies at different pressures.

16. Cutting Attachments.

Combined torch system X21 with cutting attachments of various lengths.

- Increased safety due to the fact that the oxygen can be shut off with the wheel valve on the handle. This eliminates the risk of the oxygen supply being opened accidentally
- Easy to supplement the existing X21 torch system with the desired length of cutting attachment
- Special lengths produced to order
- The torch may be used both for acetylene, propane and THERMOLEN®

X21 cutting attachment with lever



Cutting attachments – dimensions and products facts for various items above

| Nominal Length mm | Total length incl. handle | Angle torch head | Part no. |
|----------------------------------|---------------------------|------------------|----------|
| Cutting attachment | | | |
| Pressure torch | | | |
| 240 | 440 | 0° HV | 300487 |
| 240 | 440 | 45° HV | 300554 |
| 240 | 440 | 75° HV | 300500 |
| 240 | 440 | 90° HV | 300569 |
| 240 | 440 | 0° RV | 308545 |
| 240 | 440 | 75° RV | 308542 |
| 240 | 440 | 90° RV | 307324 |
| 655 | 855 | 75° HV | 300608 |
| 955 | 1155 | 75° HV | 300607 |
| Nozzle nut | | | 300595 |
| Injector torch acetylene: | | | |
| 220 | 420 | 90° HV | 308680 |
| 220 | 420 | 75° RV | 308672 |
| 220 | 420 | 90° RV | 308673 |
| Nozzle nut, injector | | | 305597 |

HV = Lever for cutting oxygen

RV = Wheel valve for cutting oxygen



300569, Cutting attachment, pressure torch with lever



307324, Cutting attachment, pressure torch with wheel valve



308680, X21 Injector cutting attachment with lever (oxygen and acetylene)



308673, X21 Injector cutting attachment with wheel valve (oxygen and acetylene)

Note!

Use a cutting attachment with wheel valve for cutting oxygen when the cutting oxygen valve is to be fully open during use.



HA 311 – Acetylene.

HA 311 is a 3-cone sealed cutting nozzle, exactly the same as COOLEX® A 311 but without a cooling flow. The nozzle has a cylindrical cutting duct and six heating flames, except for the largest nozzle, 300–500 mm, which has nine heating flames.

It is forged from a piece of copper over polished steel mandrels, which produces an even, turbulence-free flame. The smallest nozzle is known as a thin sheet metal nozzle, 1–3 mm, and is characterised by minimal heat spread and consequently little deformation of the workpiece. HA 311 has a large cutting range – a series of eight cutting nozzles for material thickness ranging from 1–500 mm.

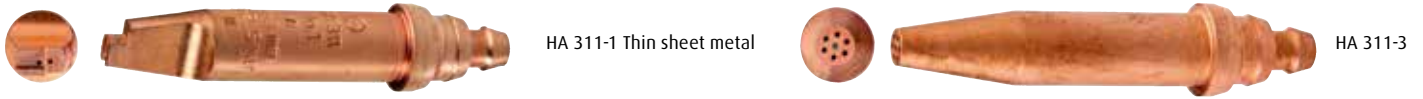

Cutting data HA 311

| Serial no. | mm | Acetylene | | Cutting oxygen | | mm/min | Part no. | |
|------------|---------|-----------|-------------------|----------------|-------------------|------------|----------|---------|
| | | bar | m ³ /h | bar | m ³ /h | | 1 pcs | 10 pack |
| HA 311-1 | 1–3 | 0.2 | 0.1 | 0.5–2.5 | 1.3 | Max. 1.000 | 305847 | 300631 |
| HA 311-2 | 3–10 | 0.2 | 0.3 | 1.0–2.5 | 1.6 | 950–430 | 305853 | 300623 |
| HA 311-3 | 10–25 | 0.2 | 0.4 | 1.5–4.0 | 3.6 | 580–350 | 305849 | 300624 |
| HA 311-4 | 25–50 | 0.2 | 0.5 | 1.5–4.0 | 6.8 | 500–300 | 305852 | 300632 |
| HA 311-5 | 50–100 | 0.2 | 0.7 | 3.0–6.0 | 7.8–14.1 | 380–180 | 305834 | 300612 |
| HA 311-6 | 100–200 | 0.2 | 0.9 | 5.0–8.0 | 15.8–23.9 | 280–120 | 305843 | 300614 |
| HA 311-7 | 200–300 | 0.3 | 1.2 | 5.0–8.0 | 23.6–36.7 | 150–100 | 305841 | 300621 |
| HA 311-8 | 300–500 | 0.3 | 3.0 | 7.0–12.0 | 43.1–68.3 | 100–50 | 305832 | 300615 |

COOLEX® P 331 – Propane.

COOLEX® P 331 is a 3-cone sealed cutting nozzle with slotted flames.

The nozzle is in two parts, and the inner nozzle has a cylindrical cutting duct. The inner nozzle is shorter than the outer nozzle, and the recessed location helps to effectively guide the propane flame, which is even and turbulence-free.



Product benefits:

- Large cutting range – a series of eight cutting nozzles for material thicknesses from 1–500 mm
- Long service life thanks to the cooling flow to the cutting oxygen duct

For more nozzles see page 50.

Cutting data P 331

| Serial no. | mm | Propane | | Cutting oxygen | | mm/min | Part no. | |
|------------|---------|---------|-------------------|----------------|-------------------|----------|----------|---------|
| | | bar | m ³ /h | bar | m ³ /h | | 1 pcs | 10 pack |
| P 331-1 | 1–3 | 0.3–1.5 | 0.1 | 0.6–1.9 | 1.6 | Max. 900 | 300675 | 300675 |
| P 331-2 | 3–10 | 0.3–1.5 | 0.2 | 0.4–0.9 | 2.7 | 850–390 | 300676 | 300676 |
| P 331-3 | 10–25 | 0.3–1.5 | 0.5 | 0.6–2.1 | 4.5 | 540–325 | 300668 | 300668 |
| P 331-4 | 25–50 | 0.3–1.5 | 0.5 | 0.8–2.4 | 7.8 | 475–285 | 300674 | 300674 |
| P 331-5 | 50–100 | 0.3–1.5 | 0.5 | 1.9–5.0 | 9.0–15.2 | 380–180 | 300671 | 300671 |
| P 331-6 | 100–200 | 0.3–1.5 | 0.5 | 3.1–5.6 | 14.7–24.3 | 280–120 | 300670 | 300670 |
| P 331-7 | 200–300 | 0.3–1.5 | 0.6 | 4.4–7.5 | 25.8–45.2 | 150–100 | 300669 | 300669 |
| P 331-8 | 300–500 | 0.3–1.5 | 1.2 | 5.5–10.5 | 41.3–75.0 | 100–50 | 300672 | 300672 |

Flame-Straightening Torch.

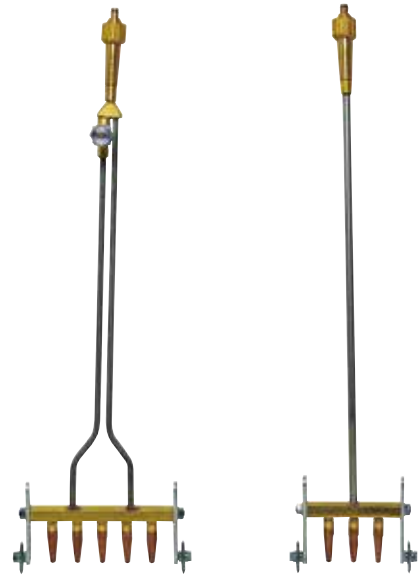
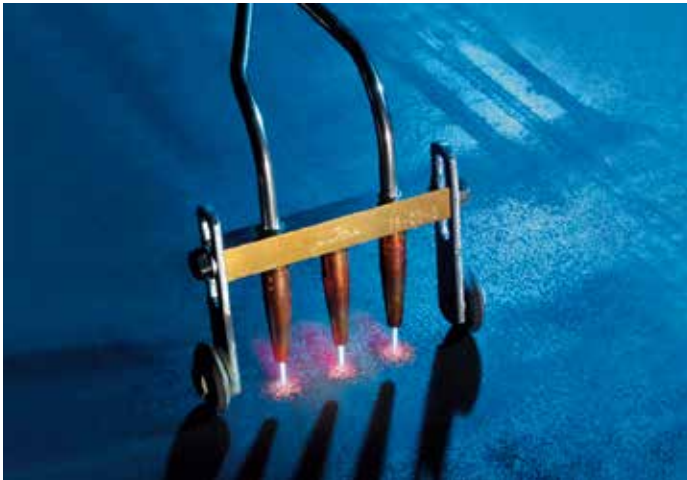

Flame-straightening torch.

| | Nozzles | Length mm | Working pressure bar | | Consumption l/h | | Part no. | |
|--|---------|-----------|----------------------|-----------|-----------------|-----------|----------|--|
| | | | Oxygen | Acetylene | Oxygen | Acetylene | | |
| Flame-straightening torch | 3 | 730 | 7 | 0.7 | 1 500 | 1 350 | 300534 | |
| | 5 | 690 | 7 | 0.7 | 2 500 | 2 250 | 300490 | |
| Nozzles for flame-straightening torch X21, 500 l | | | | | | | 300495 | |
| Wheel, incl. hub | | | | | | | 300506 | |
| Wheel holder | | | | | | | 307990 | |

Flame-Cleaning Torch.



Flame-cleaning torch

| | B mm | L mm | Working pressure bar | | Consumption l/h | | Cylinder requirement | Part no. |
|----------------------|------|------|----------------------|-----------|-----------------|-----------|----------------------|----------|
| | | | Oxygen | Acetylene | Oxygen | Acetylene | | |
| Flame-cleaning torch | 50 | 490 | 7 | 0.7 | 1 250 | 1 150 | 2 | 300538 |
| | 150 | 490 | 7 | 0.7 | 2 500 | 2 300 | 6 | 300537 |
| | 250 | 1190 | 8 | 0.8 | 4 400 | 4 050 | 10 | 300536 |

Due to the large gas consumption, outlets are required from 2 cylinders of acetylene for every 50 mm width of the flame-cleaning equipment.

Note!

Consult your material supplier regarding suitable pre-heating temperature. In order to succeed with flame straightening, heating has to take place quickly. This means that acetylene (which has the highest effective heating value of all fuel gases) and an efficient torch have to be used. The Flamtech torch meet these requirements.

Flame Straightening.

Welding and cutting causes stresses in the material that can result in unwanted deformations. If these deformations are serious, the part must be rectified. Flame straightening is usually a suitable method, and in some cases it is the only option for reducing the deformations to an acceptable level.

Flame straightening

The process takes place by means of rapid local heating, which entails a permanent local deformation of the material through the prevention of thermal expansion. During cooling, the material then shrinks. Steel must be heated to approx. 600–700°C, which causes the steel to change to a dark red colour.

Heat forming

Heating in order to bend bar profiles etc. generally requires the same rapid, brief heating as flame straightening.

Pre-heating (raised working temperature)

A welding object to be pre-heated is dependent on the type of parent material, the material thickness and which welding process is to be used. If pre-heated is required, the Flamtech torch is well-equipped for the task.

Flamtech torch

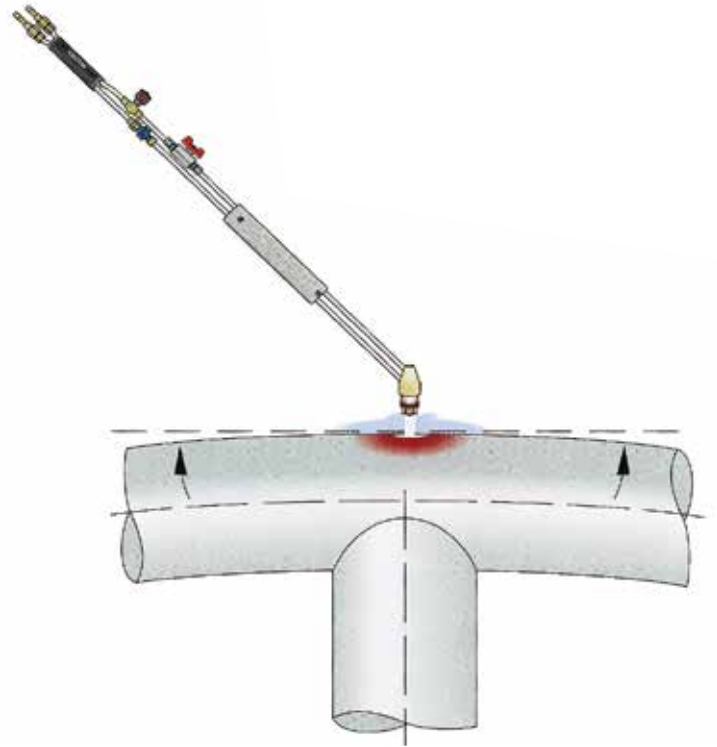

| | Part no. |
|--|----------|
| FLAMTECH torch. | 300469 |
| Nozzles | |
| MA 3 | 300611 |
| FA 6 | 300616 |
| FY 6 for THERMOLEN®, natural gas and propane | 309871 |

Note!

The acetylene gas supply to Flamtech must come from a cylinder bundle. In addition, double flashback arrestors, SAFE-GUARD-5, must be fitted with double outlets, as more than 5 m³/h of acetylene is required.

| Flame straightening | | | | |
|--|----------------|------------|-------------------|--|
| Nozzle MA3, flame straightening | | | | |
| Working pressure: | Oxygen 2 bar | 8.500 l/h | Acetylene 1 bar | |
| Lowest working pressure: | Oxygen 1.1 bar | 5.400 l/h | Acetylene 0.9 bar | |
| Heat output: 98 kW | | | | |
| Nozzle FA 6, pre-heating (raised working temperature) | | | | |
| Working pressure: | Oxygen 1.5 bar | 10.000 l/h | Acetylene 0.7 bar | |
| Lowest working pressure: | Oxygen 0.8 bar | 6.400 l/h | Acetylene 0.6 bar | |
| Heat output: 116 kW | | | | |

| Rule of thumb for acetylene output from various cylinder sizes | | |
|--|----------------------------------|------------------|
| Cylinder size | Content, filled cylinder | Maximum capacity |
| A 40 | 7.8 kg equiv. to approx. 7.170 l | 900 l/h |
| Bundle | | |
| A 40 x 10 | 62 kg equiv. to 57.000 | 10.000 l/h |

| Rule of thumb for straightening and heating | |
|---|----------------------------------|
| Material thickness x 2.5 x 100 | = Capacity of heating attachment |
| E.g. material thickness: 20 mm x 2.5 x 100 | = 4000 l/h |
| E.g. material thickness: 30 mm x 2.5 x 100 | = 7500 l/h |
| E.g. material thickness: 40 mm x 2.5 x 100 | = 10.000 l/h |

Accessories for Torch Systems.

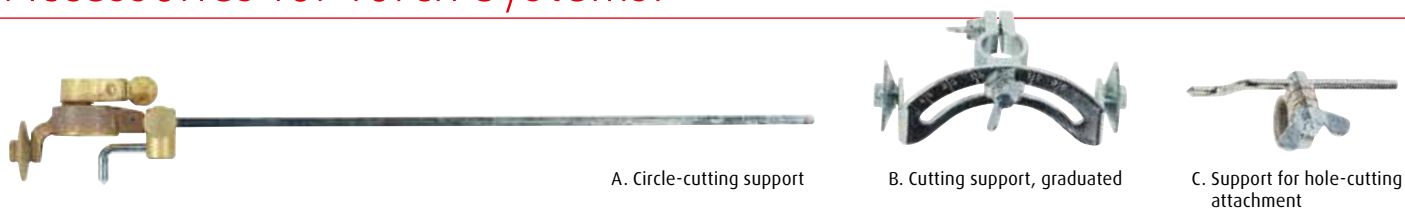

Cutting Support for X11.

| | Part no. |
|---|----------|
| A. Circle-cutting support for hole diametres Ø 60–600 mm | 300419 |
| B. Cutting support, graduated | 300414 |
| C. Support for hole-cutting attachment, hole diametres Ø 20–60 mm | 300406 |

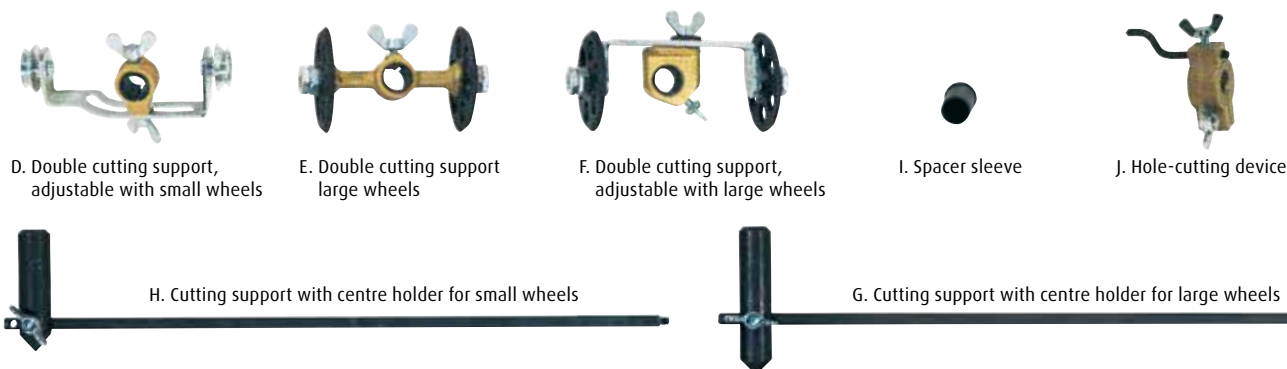

Cutting Support for X21 and X11 300350.

| | Part no. |
|---|----------|
| D. Double cutting support, adjustable with small wheels | 300576 |
| E. Double cutting support with large wheels | 300584 |
| F. Double cutting support, adjustable with large wheels | 300510 |
| G. Cutting support with centre holder for large wheels | 300575 |
| H. Cutting support with centre holder for small wheels | 300564 |
| I. Spacer sleeve | 300572 |
| J. Hole-cutting device | 300568 |

Extra Circle-Cutting Device for X21.

High quality ball bearing circle-cutting device, for narrow tolerance and high cut quality when cutting circles and holes with manual gas cutting.

The circle-cutting device is used together with X21 and similar torches, as well as all COOLEX cutting nozzles and cutting nozzle HA311.



| | Diametre mm | Part no. |
|--|-------------|----------|
| K. Circle-cutting device complete | 30–800 | 300606 |
| L. Circle-cutting device without extension bar | 30–100 | 300531 |
| M. Circle-cutting device X21 Injector complete (X 311) | 60–800 | 310358 |

Cutting Equipment.



Manual Cutting Torch X511.

X511 is a pressure torch (II) intended for manual gas cutting.

The capacity is sufficient for material thicknesses up to 500 mm. X511 is designed to meet requirements set out in EN ISO 5172. Acetylene, propane, thermolen or natural gas can be used as the fuel gas, and it has a lockable lever valve for the cutting oxygen. X511 has wheel valves installed on the side and a flat handle. All COOLEX®, HA 311.

→ Non-return valves are not included.

| X511 | | |
|-----------|--------------|----------|
| Length mm | Nozzle mount | Part no. |
| 470 | 90° | 300696 |
| 470 | 75° | 300691 |
| 855 | 75° | 300690 |
| 1.080 | 75° | 300679 |
| | Nozzle nut | 300595 |



Manual Cutting Torch X 31.

X 31 is a pressure torch and is intended for manual gas cutting. The cutting capacity is sufficient for material thicknesses up to 500 mm. The handle is round, and there are oxygen and fuel gas valves at the rear of the torch handle. The lever valve for the cutting oxygen is lockable. The gas pipes are made of stainless steel. Acetylene, propane, thermolen or natural gas can be used as the fuel gas. The torch meets the requirements set out in EN ISO 5172. Non-return valves are not included.

| X 31 | | |
|-----------|--------------|----------|
| Length mm | Nozzle mount | Part no. |
| 470 | 90° | 305578 |
| 470 | 75° | 305558 |
| | Nozzle nut | 300595 |



Manual Cutting Torch SIDER 7.

The SIDER 7 injector torch is a robust cutting torch for propane and oxygen. It is durable and reliable. It meets the requirements set out in EN ISO 5172. The stainless steel pipes are placed in a triangular layout for optimum stability. The mixing chamber is placed in the cutting head and the cutting oxygen valve is designed for soft-starting the cutting process. SIDER 7 has a cutting capacity of up to 300 mm. Supplied with non-return valves.



| | Length mm | Weight g | Connections | Part no. |
|-------------------|-----------|----------|-----------------|----------|
| SIDER 7 | 920 | 1.400 | 3/8" RH-3/8" LH | 315502 |
| SIDER 7 Long | 1.500 | 1.600 | 3/8" RH-3/8" LH | 330468 |
| Nozzle nut | | | | 323412 |

NFF Cutting Nozzle for SIDER 7 Scrap Cutting Torch.

| Cutting data NFF | | | | | | |
|------------------|------------------|---------|------|---------|-----------|----------|
| Serial no. | Cutting range mm | Propane | | Oxygen | | Part no. |
| | | bar | m³/h | bar | m³/h | |
| NFF-1 | 6-25 | 0.5 | 0.4 | 2.5-3.5 | 3.5-4.5 | 315501 |
| NFF-2 | 25-50 | 0.5 | 0.4 | 3.0-4.0 | 4.0-4.8 | 315497 |
| NFF-3 | 50-75 | 0.5 | 0.4 | 3.0-4.5 | 5.0-6.5 | 315496 |
| NFF-4 | 75-150 | 0.5 | 0.5 | 3.5-5.5 | 6.5-9.5 | 315499 |
| NFF-5 | 150-200 | 0.5 | 0.6 | 4.5-5.5 | 10.0-14.0 | 315500 |
| NFF-6 | 200-300 | 0.5 | 0.7 | 5.0-6.5 | 15.0-19.0 | 315498 |



Lance.

The lance works quickly and quietly in aluminium, stainless steel, cast iron, copper and concrete.

The lance (torch lance) is a tool for making holes and cutting hard materials (reinforced concrete, natural stone, bricks, acid-resistant steel, cast iron). The lance works without noise or vibrations.

Areas of application: all cutting of scrap, sheet pile walls, underwater cutting and similar cutting of materials where normal thermal cutting cannot be used.

Work execution

The lance is lit against a wood block with a small volume of oxygen, and applied at an angle against the surface to be processed.

When the lance has begun to burn, the oxygen pressure is increased.

The lance burns at a temperature of approx. 3.000°C, at which concrete and similar materials sinter ("melt"). Hole diameter approx. 40 mm.

An area of approx. 30 mm around the torch hole is affected by the heat generation. The lance can be bent, making it possible to make holes behind obstacles such as pipelines, etc.



316653, Lance holder Model C, incl. non-return valve

| Lance | | | | | | | |
|------------|-------------------|------------------|------------|--------------------------------|---------|-----------|----------------------|
| Lance Ø mm | Cutting direction | Hole diameter mm | Oxygen bar | Consumption during hole making | | | Cutting speed mm/min |
| | | | | Oxygen m ³ | Lance m | Time min. | |
| 16 (3/8") | Horizontal | 40 | 6.0 | 2.3 | 5.4 | 5.4 | 190 |
| 16 (3/8") | Overhead | 40 | 6.0 | 2.5 | 6.0 | 6.0 | 165 |

| | Part no. |
|--|----------|
| Lance holder Model C, incl. non-return valve | 316653 |
| Lance Ø 16 x 3000 | 300736 |
| Hose fitting 8 mm | 316810 |
| Nut | 316811 |
| Lance Ø 13 x 2000 | 335867 |



316811, Nut

316810, Hose fitting 8 mm



Enlighten yourself.

Safety tips, welding trix, application
and inspiration stories at
magazine.aga.com



Choose your language at
magazine.aga.com



Premium
Cutting
Nozzles.

Function and Maintenance.

A cutting nozzle has two main functions:

- To guide the heating flame
- To guide the cutting oxygen jet

The heating flame's task is to:

- Heat a point on the workpiece to its ignition temperature
- Retain the ignition temperature at the surface during the cutting process
- Clean the surface of impurities in order to facilitate the cutting oxygen jet's contact
- Protect and support the cutting oxygen jet

The cutting oxygen jet's task is to:

- Strike the cut surface with high levels of gas purity and precision
- Burn iron to produce iron oxide
- Blow the iron oxide and other slag products out of the cut

Important! Maintenance and choice of cutting nozzles

In order to achieve the best cutting results, it is extremely important for the cutting nozzle to be cleaned and maintained regularly.

The choice of cutting nozzle is primarily dependent on:

- Type of fuel gas, normally acetylene or propane
- Type of cutting torch, normally for flat-sealed or 3-cone sealed nozzles
- Type of cutting; scrap cutting or quality cut with the highest possible cutting speed

After that, select nozzle size according to the material thickness to be cut. There are various cutting nozzles for special tasks such as gouging and rivet cutting.

Design of cutting ducts

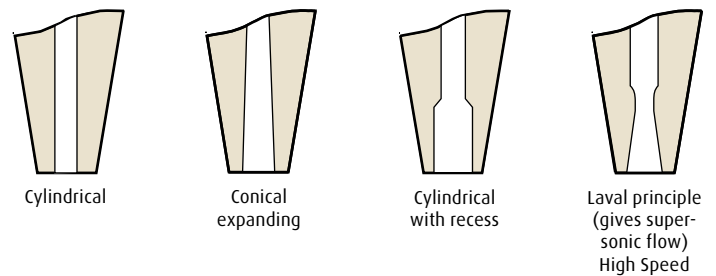

| Injector torch | Acetylene | Page | Propane | Page |
|--|-------------------|-------|---------------|------|
| Small injector torches (i) | | | | |
| X11 | HA 411 | 33 | HP 433 | 33 |
| Other injector torches (i) | | | | |
| X21 injector torch | *MA 133 D | 55 | | |
| | HA 121 | 55 | | |
| Gouging | | | | |
| X21 injector torch | JETGROOVER® | 57 | | |
| Pressure torch | | | | |
| Pressure torches (II) Manual cutting torches: | | | | |
| X21 | Coolex A311/HA311 | 53/42 | COOLEX® P 331 | 42 |
| Scrap cutting | | | | |
| | COOLEX® A 317 | 53 | COOLEX® P 337 | 54 |
| Rivet cutting | | | | |
| | COOLEX® A 341 BL | 58 | | |
| Gouging | | | | |
| | COOLEX® A 361 | 58 | | |
| | COOLEX® A 351 B | 58 | | |
| | COOLEX® A 353 BL | 59 | | |

* Recommended for mechanised cutting

COOLEX® – 3-Cone Sealed Cutting Nozzles for Pressure Torches.

COOLEX® is the generic name for AGA's 3-cone sealed cutting nozzles, which are a development of conventional cutting nozzles. The COOLEX® nozzles have a cooling flow duct that is an AGA patent.

In a conventional cutting nozzle, hot gas penetrates from the heating flame into the cutting duct, causing inappropriate heating of the cutting nozzle, often up to 500°C.

This means that cutting spatter and combustion residue adhere more easily to the nozzle and its outlet ducts, which in turn impairs the cutting process in the form of poorer cut quality and more stoppages and interruptions to production. The COOLEX® nozzles with a cooling flow duct improve the cut quality and increase accessibility through fewer operational interruptions. This is thanks to the small cooling flow (approx. 25–50 l/h) that is routed from the heating oxygen duct to the cutting oxygen duct.

Torch head

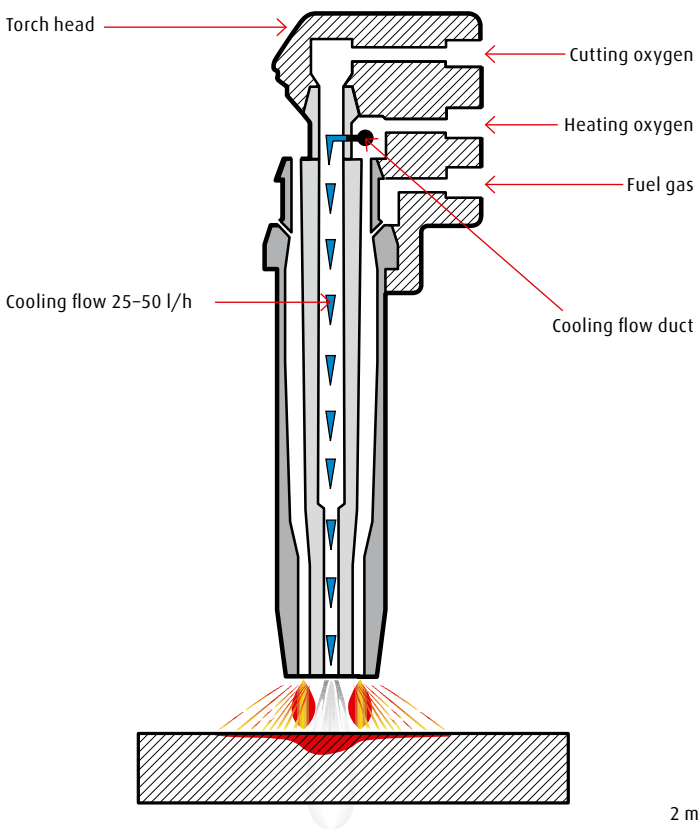

Temperature measurement in the cutting nozzles

■ Nozzle without cooling

■ Nozzle with cooling

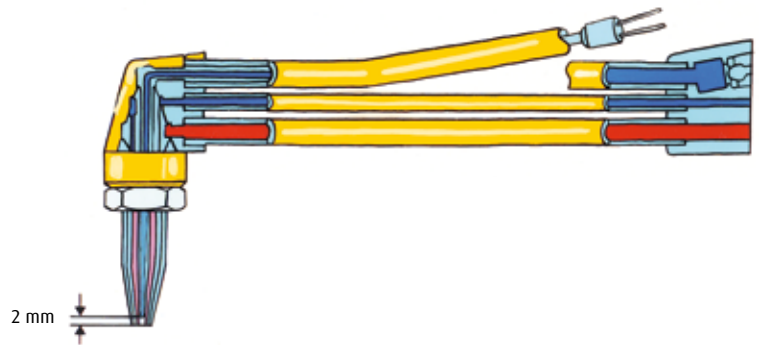
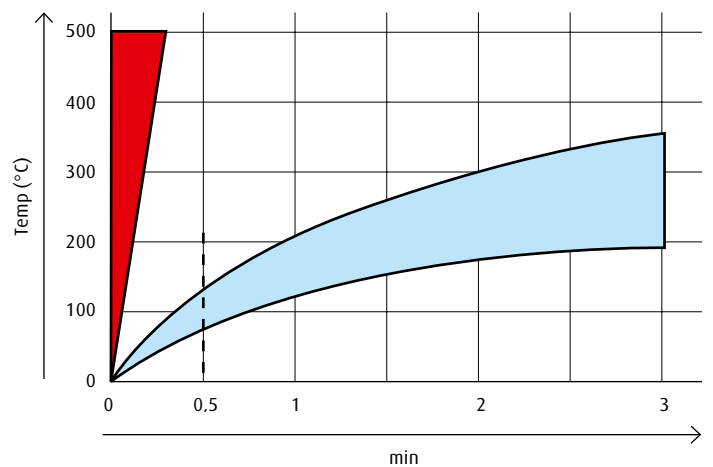

Premium Nozzles for X21.

COOLEX® A 311 – Acetylene.

COOLEX® A 311 is a 3-cone sealed cutting nozzle.

Product benefits:

- Large cutting range – a series of eight cutting nozzles for material thicknesses from 1–500 mm
- Long-lasting thanks to the cooling flow
- It is forged from a single piece of copper, which produces an even, turbulence-free flame
- The smallest nozzle is known as a thin sheet metal nozzle, 1–3 mm, and is characterised by minimal heat spread and consequently little deformation of the workpiece
- Use cleaning method: cleaning needle

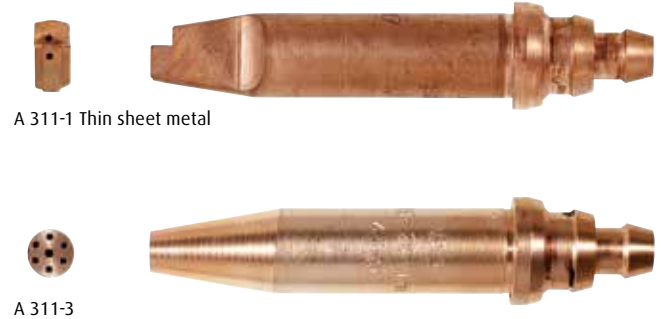

| Coolex A 311 | | | | | | | | |
|--------------|---------|-----------|-------------------|----------|-------------------|------------|----------|--------|
| | | Acetylene | | | Cutting oxygen | | | |
| Serial no. | mm | bar | m ³ /h | bar | m ³ /h | mm/min | Part no. | 1 pack |
| A 311-1 | 1–3 | 0.2 | 0.1 | 0.5–2.5 | 1.3 | Max. 1.000 | 300640 | |
| A 311-2 | 3–10 | 0.2 | 0.3 | 1.0–2.5 | 1.6 | 950–430 | 300639 | |
| A 311-3 | 10–25 | 0.2 | 0.4 | 1.5–4.0 | 3.6 | 580–350 | 300643 | |
| A 311-4 | 25–50 | 0.2 | 0.5 | 1.5–4.0 | 6.8 | 500–300 | 300644 | |
| A 311-5 | 50–100 | 0.2 | 0.7 | 3.0–6.0 | 7.8–14.1 | 380–180 | 300645 | |
| A 311-6 | 100–200 | 0.2 | 0.9 | 5.0–8.0 | 15.8–23.9 | 280–120 | 300642 | |
| A 311-7 | 200–300 | 0.3–0.8 | 1.2 | 5.0–8.0 | 23.6–36.7 | 150–100 | 300641 | |
| A 311-8 | 300–500 | 0.3–0.8 | 3.0 | 7.0–12.0 | 43.1–68.3 | 100–50 | 300638 | |

COOLEX® A 317 – Acetylene.

Scrap cutting nozzles.

Product benefits:

- Specially adapted for scrap cutting
- Rapid cutting start thanks to effective heating flames
- Increased productivity thanks to the fact that each nozzle has a large cutting range, which means fewer stoppages for nozzle replacement
- Long-lasting thanks to the cooling flow
- COOLEX® A 317 is a 3-cone sealed flicker flame nozzle that is forged from a single piece of copper
- Use cleaning method: cleaning needle



| COOLEX® A 317 | | | | | | | | | |
|---------------|---------|-----------|-------------------|-------------------|----------------|-------------------|---------|----------|--|
| | | Acetylene | Heating oxygen | | Cutting oxygen | | | | |
| Serial no. | mm | bar | m ³ /h | m ³ /h | bar | m ³ /h | mm/min | Part no. | |
| A 317-1 | 3–50 | 0.3–0.8 | 0.7–1.0 | 0.8–1.2 | 1.0–3.1 | 2.4–5.2 | 480–370 | 300662 | |
| A 317-2 | 50–100 | 0.3–0.8 | 1.1 | 1.2 | 1.8–4.9 | 5.3–11.3 | 370–240 | 300673 | |
| A 317-3 | 100–200 | 0.5–0.8 | 1.1–1.3 | 1.2–1.5 | 4.2–7.4 | 13.3–21.5 | 280–150 | 300661 | |
| A 317-4 | 200–300 | 0.5–0.8 | 1.3 | 1.5 | 4.3–7.3 | 22.4–34.2 | 150–100 | 300660 | |
| A 317-5 | 300–500 | 0.8 | 2.8–3.0 | 3.2–3.3 | 5.9–8.5 | 36.5–50.0 | 100–50 | 300659 | |

COOLEX® P 337 – Propane.

Scrap cutting nozzles.

COOLEX® P 337 is a 3-cone sealed, two-part slotted flame nozzle with cylindrical cutting duct.

Product benefits:

- Specially adapted for scrap cutting
- Rapid cutting start thanks to effective heating flames
- Increased productivity thanks to the fact that each nozzle has a large cutting range, which means fewer stoppages for nozzle replacement
- Long-lasting thanks to the cooling flow



| COOLEX® P 337 | | | | | | | | | |
|---------------|---------|---------|-------------------|-------------------|----------------|-------------------|----------------|----------|--|
| | | Propane | | | Heating oxygen | | Cutting oxygen | | |
| Serial no. | mm | bar | m ³ /h | m ³ /h | bar | m ³ /h | mm/min | Part no. | |
| P 337-1 | 3-50 | 1.0 | 0.9 | 3.5 | 4.0 | 6.0 | 1000-325 | 300647 | |
| P 337-2 | 50-100 | 1.0 | 1.3 | 5.0 | 5.0 | 10.0 | 380-180 | 300657 | |
| P 337-3 | 100-200 | 1.0 | 1.6 | 6.4 | 7.0 | 25.0 | 280-120 | 300655 | |
| P 337-4 | 200-300 | 1.0 | 2.3 | 9.2 | 8.0 | 40.0 | 150-100 | 300656 | |
| P 337-5 | 300-500 | 1.0 | 3.0 | 12.0 | 12.0 | 72.0 | 100-50 | 300654 | |

Cutting Nozzles X21 Injector.

HA 121 – Acetylene.

HA 121 is a flat-sealed ring flame nozzle with a cylindrical cutting duct and ring-shaped heating flame.

The nozzle comprises three parts: fitting, inner nozzle and outer nozzle.
HA 121 is intended for cutting material thicknesses up to 150 mm.

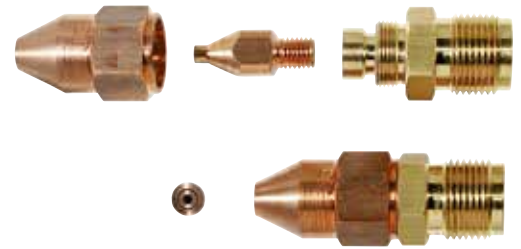

| HA 121 | | Acetylene | | Cutting oxygen | | mm/min | Part no. | |
|------------|--------|-----------|-------------------|----------------|-------------------|---------|----------|---------|
| Serial no. | mm | bar | m ³ /h | bar | m ³ /h | | 1 pack | 10 pack |
| HA 121-0 | 5-10 | 0.1-0.8 | 0.3 | 4.0-5.0 | 1.1-1.8 | 625-500 | 309287 | |
| HA 121-1 | 5-20 | 0.1-0.8 | 0.3 | 5.0-6.0 | 1.1-2.4 | 625-350 | 309302 | 309286 |
| HA 121-2 | 20-30 | 0.1-0.8 | 0.4 | 6.0-7.0 | 2.4-4.5 | 350-300 | 309301 | 309285 |
| HA 121-3 | 30-75 | 0.1-0.8 | 0.5 | 6.5-7.5 | 4.5-9.5 | 300-215 | 309300 | 309284 |
| HA 121-4 | 75-150 | 0.1-0.8 | 0.6 | 7.0-7.5 | 9.5-13.9 | 215-90 | 309289 | |

MA 133D – Acetylene.

MA 133D is a flat-sealed, 2-part slotted flame nozzle. It can be used for all gas cutting up to material thicknesses of 300 mm.

→ The outer nozzle is made of chrome-plated copper, which means that it is more difficult for spatter and slag to adhere to the nozzle. The inner nozzle is made of copper. The heating flame's properties, together with the expanding cutting ducts, produce a very concentrated and stable cutting oxygen jet, which provides the potential for a high cutting speed and cut quality

Product benefits and areas of application:

- With a knowledge of the gas cutting process and the correct gas supply, a high cutting speed (e.g. 700 mm per minute in a material thickness of 10 mm) can be used in production
- High cut quality



| MA 133D | | Acetylene | | Heating oxygen | | Cutting oxygen | | mm/min | Part no. | |
|------------|---------|-----------|-------------------|----------------|-------------------|----------------|-------------------|---------|----------|---------|
| Serial no. | mm | bar | m ³ /h | bar | m ³ /h | bar | m ³ /h | | 1 pack | 10 pack |
| MA 133D-0 | 3-8 | 0.2-0.8 | 0.5 | 1.5 | 0.6 | 3.5-5.0 | 1.3-1.9 | 900-650 | 305762 | 305817 |
| MA 133D-1 | 8-15 | 0.2-0.8 | 0.5 | 1.5 | 0.6 | 5.0-6.0 | 2.3-2.6 | 725-600 | 305760 | 305818 |
| MA 133D-2 | 15-30 | 0.2-0.8 | 0.5 | 1.5 | 0.6 | 6.0-7.0 | 3.6-4.2 | 680-460 | 305770 | 305727 |
| MA 133D-3 | 30-50 | 0.2-0.8 | 0.5 | 1.5 | 0.6 | 6.5-7.5 | 5.2-5.9 | 575-360 | 305746 | 305729 |
| MA 133D-4 | 50-70 | 0.2-0.8 | 0.7 | 2.3 | 0.7 | 7.0-7.5 | 7.5-8.0 | 475-340 | 305768 | 305730 |
| MA 133D-5 | 70-100 | 0.2-0.8 | 0.7 | 2.3 | 0.7 | 7.0-8.0 | 11.1-12.3 | 365-280 | 305767 | 305735 |
| MA 133D-6 | 100-200 | 0.5-0.8 | 0.7-0.8 | 2.0-5.0 | 0.8-0.9 | 6.0-8.0 | 11.7-15.7 | 250-150 | 305731 | 305732 |
| MA 133D-7 | 200-300 | 0.5-0.8 | 1.0-1.3 | 2.0-5.0 | 1.1-1.5 | 6.0-7.0 | 26.8-31.0 | 180-110 | 305728 | 309346 |

Gouging.



Gouging X21 Injector.

JETGROOVER® – Acetylene.

JETGROOVER® is a 2-part slotted flame nozzle. It is made of copper with a chrome-plated outer nozzle to reduce adhesion of cutting spatter and slag.

The cutting oxygen duct is designed to produce a turbulent cutting oxygen duct with a larger diameter and lower outflow speed compared to a conventional cutting nozzle.

Product benefits:

- High processing capacity
- Powerful heating flame for rapid start
- Short nozzle for good accessibility

Areas of application:

- Gouging grooves for post-welded root or other joint preparation
- Gouging away fillet welds
- Good method for removing defects in welded joints, as it is easier to see pores, cracks, etc. compared to arc air gouging and grinding



Cutting data JETGROOVER®

| Serial no. | Acetylene | | Heating oxygen | | Cutting oxygen | | mm/min | Part no. 1 pack |
|------------|-----------|-----|----------------|-------------------|----------------|-------------------|-----------|--------------------|
| | mm | mm | bar | m ³ /h | bar | m ³ /h | | |
| No. 0 | 5-6 | 2-4 | 0.3-0.8 | 1.3-1.7 | 5.0-7.0 | 3.6-4.9 | 400-1 400 | 309332 |
| No. 1 | 5-8 | 4-6 | 0.3-0.8 | 1.6-2.2 | 6.5-9.0 | 5.0-6.6 | 400-1 400 | 309331 |
| No. 2 | 7-10 | 5-8 | 0.3-0.8 | 1.1-1.6 | 4.0-6.0 | 6.6-9.4 | 400-1 400 | 309097 |

Premium Nozzles for X21.

COOLEX® A 341 BL – Acetylene.

Rivet cutting nozzle

- COOLEX® A 341 BL is a rivet cutting nozzle of the flicker flame type, forged from a single piece of copper
- The nozzle is bent for good accessibility
- Use cleaning method: KR21

Areas of application:

- Specially intended for separating rivet joints and screw joints that have rusted solid
- Cutting convex rivet heads or nuts and screws
- Separating welded joints welded in T-grooves, which are cut off level with the sheet metal



| Coolex A 341 | | | | | | | | | |
|--------------|---------|-----------|-------------------|---------|-------------------|---------|--------------------|--|--|
| | | Acetylene | | | Cutting oxygen | | | | |
| Serial no. | mm | bar | m ³ /h | bar | m ³ /h | mm/min | Part no. 1 pack | | |
| A 341 BL-2 | 5-25 | 0.2-0.5 | 0.5 | 3.0 | 2.8-3.8 | 340-260 | 300666 | | |
| A 341 BL-3 | 25-50 | 0.2-0.5 | 0.5 | 4.0 | 4.6 | 320-240 | 300665 | | |
| A 341 BL-4 | 50-100 | 0.2-0.5 | 0.6 | 3.0-6.0 | 5.5 | 270-160 | 300664 | | |
| A 341 BL-5 | 100-200 | 0.2-0.5 | 0.7-0.8 | 4.0-7.0 | 6.5-7.7 | 220-120 | 300663 | | |

Gouging X21.

COOLEX® A 361 – Acetylene.

COOLEX® A 361 is a gouging nozzle of the flicker flame type, forged from a single piece of copper. It has an expanding cutting oxygen duct and six powerful heating flames.

The cutting oxygen duct is designed to produce a turbulent cutting oxygen duct with a larger diameter and lower outflow speed compared to a conventional cutting nozzle.

Product benefits:

- Turbulent cutting oxygen jet which combines with heating flames for a high level of processing
- Powerful heating flames for a rapid start
- Robust and long-lasting



| Cutting data COOLEX A 361 | | | | | | | | |
|---------------------------|-------|-----|-----------|-------------------|----------------|-------------------|--------|--------------------|
| | | | Acetylene | | Cutting oxygen | | | |
| Serial no. | mm | mm | bar | m ³ /h | bar | m ³ /h | mm/min | Part no. 1 pack |
| A 361-8 | 8-9 | 3-4 | 0.2-0.5 | 0.5 | 4.0 | 3.1 | 600 | 300646 |
| A 361-10 | 11-12 | 3-6 | 0.2-0.5 | 0.6 | 4.0 | 5.6 | 1 000 | 300653 |
| A 361-12 | 12-14 | 5-7 | 0.2-0.5 | 0.8 | 4.0 | 8.7 | 1 200 | 300652 |

COOLEX® A 351 B – Acetylene.

COOLEX® A 351 B is a gouging nozzle of the flicker flame type, forged from a single piece of copper. It has a cylindrical cutting oxygen duct (step nozzle) and seven powerful heating flames. The nozzle is curved and fitted with a support lug.

Product benefits:

- Turbulent cutting oxygen jet which combines with heating flames for a high level of processing
- Powerful heating flames for a rapid start
- Support lug that, in certain cases, significantly facilitates gouging
- Robust with a long service life



Cutting data COOLEX® A 351 B

| Serial no. | mm | mm | Acetylene | | Cutting oxygen | | mm/min | Part no. 1 pack |
|------------|-------|-------|-----------|-------------------|----------------|-------------------|--------|--------------------|
| | | | bar | m ³ /h | bar | m ³ /h | | |
| A 351 B-8 | 6-8 | 3-6 | 0.2-0.5 | 0.9 | 5.0 | 5.3 | 600 | 300637 |
| A 351 B-10 | 8-11 | 6-11 | 0.2-0.5 | 1.8 | 6.0 | 10.8 | 1 000 | 300658 |
| A 351 B-12 | 11-13 | 10-13 | 0.2-0.5 | 2.2 | 7.0 | 19.7 | 1 200 | 300667 |

COOLEX® A 353 BL – Acetylene.

COOLEX® A 353 BL is a gouging nozzle of the flicker flame type, forged from a single piece of copper. It has an expanding cutting oxygen duct and six powerful heating flames. The nozzle is curved and long.

Product benefits:

- Turbulent cutting oxygen jet which, in combination with the heating flames, produces a high level of processing
- Powerful heating flames for rapid start
- Robust with a long service life



Cutting data COOLEX® A 353 BL

| Serial no. | mm | mm | Acetylene | | Cutting oxygen | | mm/min | Part no. 1 pack |
|-------------|-------|-------|-----------|-------------------|----------------|-------------------|--------|--------------------|
| | | | bar | m ³ /h | bar | m ³ /h | | |
| A 353 BL-6 | 6-8 | 3-8 | 0.5 | 1.2 | 6.0 | 5.0 | 600 | 300651 |
| A 353 BL-8 | 8-11 | 6-11 | 0.5 | 1.7 | 6.8 | 11.5 | 1 000 | 300650 |
| A 353 BL-10 | 9-12 | 8-11 | 0.5 | 2.0 | 6.5 | 15.0 | 1 000 | 300649 |
| A 353 BL-12 | 10-15 | 10-13 | 0.5 | 2.3 | 6.5 | 19.0 | 1 200 | 300648 |



Accessories.

Flashback Arrestor SAFE-GUARD-5.



SAFE-GUARD-5 has five safety functions:

- Turns off the gas supply in the event of penetrating flashbacks
- Stops and extinguishes penetrating flashbacks
- Prevents backflow
- Turns off the gas supply in the event of overheating (95°C)
- Simple and effective reset function

It has a connection angle of 30°. The advantage of this is that, when connected to regulators, the flashback arrestor will sit parallel with the gas cylinder.

The lever is coloured. If a flashback occurs, the lever flips out and the gas flow is stopped. To restore a flashback push the lever back and the gas flow is opened.

Flashback arrestors should also be used for propane. As oxygen increases the combustion speed, flashback arrestors should also be installed on the oxygen regulator.

SAFE-GUARD-5 is designed and manufactured according to EN 730-1. Complies with standards confirmed by BAM.

According to the Swedish National Inspectorate of Explosives and Flammables' Statute Book (SÄIFS 1998:7) in Sweden, as well as corresponding authorities in Denmark and Norway, approved flashback protection must be used on all regulators and outlet points for acetylene. In Finland, flashback arrestors are required for both acetylene and oxygen.

This is according to the standard SFS 5900, "Hot work safety in assembly, maintenance and repair work" and the insurance companies' safety instruction C8: "Flammable and roof repair work".

Danish Working Environment Authority's Statutory Order AT no. 147 and Statutory Order AT no. 289.

Flashback arrestor SAFE-GUARD-5

| | Gas | Connection | Part no. |
|--------------|-------------------|------------|----------|
| SAFE-GUARD-5 | Acetylene/Propane | LH G 3/8" | 332143 |
| SAFE-GUARD-5 | Oxygen | G 3/8" | 332142 |

Control

Flashback arrestors must be present on regulators/gas outlets for acetylene according to the Swedish National Inspectorate of Explosives and Flammables' regulation regarding flammable gas in single containers, SÄIFS 1998:7.

The flashback arrestor's blocking and protective functions must be tested every 24 months according to SÄIFS 1998:7. This should be carried out as external testing in an authorised workshop.

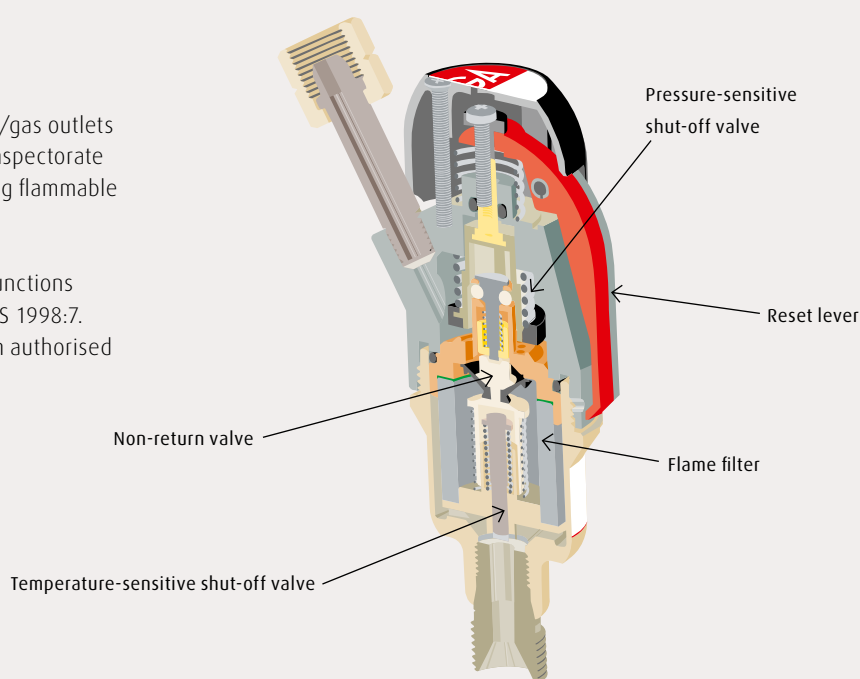

Flashback Arrestor SUPER 55.

The flashback arrestors should be used with a regulator for combustible gas and oxygen when these are used for gas welding, cutting or heating.

SUPER 55 has four safety functions:

- Prevents backflow
- Stops and extinguishes back-burning
- Cuts off the supply of gas in the event of pervasive backflow
- Cuts off the supply of gas in the event of overheating

| SUPER 55 | | | |
|-----------|--------------------------|-------------|----------|
| Gas | Max. inlet pressure, bar | Connections | Part no. |
| Acetylene | 1.5 | G 3/8" LH | 316570 |
| Propane | 5.0 | G 3/8" LH | 316570 |
| Hydrogen | 3.0 | G 3/8" LH | 316570 |
| Oxygen | 20.0 | G 3/8" RH | 316571 |

Double outlet.

When more acetylene than 5 m³/h at a working pressure of 1.5 bar or 3 m³/h at 0.8 bar (the gas flow varies with the back pressure) is required, two flashback arrestors must be connected in parallel.

Flow

At 0.7 bar and

- Free outlet 13.3 m³/h
- Back pressure 0.2 bar (standard test value) 10.4 m³/h

| Double outlet | | | |
|---------------------|-------------------|------------|----------|
| | Gas | Connection | Part no. |
| Double outlet 2 pcs | Acetylene/Propane | LH G 3/8" | 300156 |
| Double outlet 2 pcs | Oxygen | G 3/8" | 300151 |

One Regulator – Two Outlets.

Double gas outlet from one cylinder regulator.

Flow

At 0.7 bar and

- Free outlet 13.3 m³/h
- Back pressure 0.2 bar (standard test value) 10.4 m³/h

| Double outlet | | |
|--|-----------|----------|
| Gas | Qty | Part no. |
| Acetylene, Hydrogen | LH G 3/8" | 300148 |
| Oxygen, Argon, Helium, Carbon dioxide, Nitrogen, Air | G 3/8" | 300145 |

* In order to use a double outlet, two flashback arrestors are required

Two Regulators – One Gas Cylinder.

T-piece makes it possible to connect two regulators on one gas cylinder.

| Two regulators – one gas cylinder | | |
|-----------------------------------|----------------|----------|
| Gas | Connection | Part no. |
| Acetylene | LH G 3/4" | 300160 |
| Oxygen | W 21.8 x 1/4" | 300163 |
| Argon, Nitrogen | W 24.32 x 1/4" | 300088 |

* For acetylene, flashback arrestors are required on both regulators

When SUPER 55 is closed due to backflow or flashback, this is indicated by a red colour. Reset is done by lifting the cover until the red indicator disappears. SUPER 55 is suitable for most types of work except high capacity application. The capacity can be doubled by using two SUPER 55s in parallel.



Safety Goggles.

| Safety Goggles XC | Part no. |
|--------------------------------|----------|
| Safety Goggles XC clear lenses | 329999 |
| Safety Goggles XC DIN 3 lenses | 330017 |
| Safety Goggles XC DIN 5 lenses | 330012 |



Modern safety goggles with full coverage, non-fogging/scratch resistant lenses made of polycarbonate. Blue frame with adjustable side pieces for a perfect fit. Replaceable lenses. Potential to fit RX insert for correction glass. Corresponds to EN166 class 1FT. DIN3/5 lenses also correspond to EN169.

| Safety Goggles Duality | Part no. |
|-------------------------------------|----------|
| Safety Goggles Duality clear lenses | 329997 |
| Safety Goggles Duality DIN 3 lenses | 330010 |
| Safety Goggles Duality DIN 5 lenses | 330013 |



Traditional safety goggles with excellent coverage via integral protection at the sides. Side piece length adjustment. Potential to adjust the angle of the twistable side pieces. Corresponds to EN166 class 1FT. DIN3/5 lenses also correspond to EN169.

| Safety Goggles Neptun | Part no. |
|-----------------------|----------|
| Neptun shade level 5 | 300864 |



Safety Goggles with shade level 5 for gas welding, soldering and gas cutting. Neptun are ventilated and also have a flip-front mechanism. CE approved in accordance with EN 175/EN 166-F.

| Polysafe safety goggles for visitor | Part no. |
|-------------------------------------|----------|
| Safety Goggles Polysafe | 322440 |



Safety Goggles for visitors with full-coverage polycarbonate lens in a single piece. Integral side protection and contoured nose bridge. Perforated side pieces for fitting extra safety bands. Corresponds with EN166 and EN167.

Lenses.

| Lenses to goggles Ø 50 mm | | | | |
|---------------------------|--------------------|---|-----|----------|
| | Sealing level, DIN | Area of application/description | Qty | Part no. |
| Welding glass | 4 | Gas cutting, aluminium welding, weld and hard-soldering | 4 | 300819 |
| Welding glass | 5 | Gas welding of more slender material thicknesses | 4 | 300821 |
| Welding glass | 6 | Gas welding and cutting of thicker material thicknesses | 4 | 300791 |
| Grinding glass | Clear | Shatterproof | 2 | 300790 |

Cylinder Carts.

The cylinder carts are powder painted and can be ordered with either solid or puncture-proof wheels.

Cylinder transport cart

For transporting 1 x 20–50 litre cylinder.

Universal transport cart

For transporting one cylinder of any size from GENIE®, propane, refrigerants and gas cylinders.

AO 20

For mobile storage of 2 x 20 litre cylinders. The cart is CE marked and approved for lifting.

AO 50

For mobile storage of 2 x 40 or 50 litre cylinders. The cart is equipped with a practical storage box that can be supplied with a padlock. The cart is CE marked and approved for lifting.

AO 5/10

Small cylinder trolley perfect for 2 ea 5/10 litres cylinder, with a small storage box.

FLAME® flexible gas cart

Suitable for both 5/10 litres cylinder. The cart is CE marked and approved for lifting, and is supplied with puncture-proof wheels as standard.

AGA Kart

Can always sit below the cylinder. It is also possible to move the gas cylinder up stairs with the aid of the cart.

Note! Max. 20 litre cylinder. The cylinder must be anchored to a wall if it is standing in the AGA Kart.



Transport Carts Overview.



| Transport carts | | | | | | | |
|----------------------|---|---|--|---|--|---|--|
| | Cylinder transport cart 316759 | Universal transport cart 334172 | A020 334165 | A050 334166 | A05/10 334286 | Flame 334184* / 334183 | AGA Kart 320727 |
| Part no. | 316759 | 334172 | 334165 | 334166 | 334286 | 334184* / 334183 | 320727 |
| Weight kg | 9 | 12 | 13 | 32 | 10 | 10 | 2.5 |
| Length mm | 470 | 492 | 690 | 1 025 | 337 | 440 | 120 |
| Width mm | 445 | 548 | 480 | 790 | 514 | 400 | 270 |
| Height mm | 1 110 | 1 164 | 1 150 | 1 325 | 715-1 125 | 990 | 150 |
| CE marked | No | No | Yes | Yes | | Yes | |
| Approved for lifting | No | No | Yes | Yes | No | Yes | No |
| Storage box | No | No | No | Yes | Yes | Yes* | No |
| 5-10 litre cylinder | | | | | 2 ea | 2 ea | 1 ea |
| 20 litre cylinder | 1 ea | | 2 ea | | | | 1 ea |
| 50 litre cylinder | 1 ea | 1 ea | | 2 ea | | | |
| Genie cylinder | | 1-2 ea | | | | | |
| Refrigerant cylinder | | 1 ea | | | | | |
| Propane cylinder | | 1-2 ea | | | | | |
| Type of wheels | Solid | Puncture-proof | Puncture-proof | Puncture-proof | Solid | Puncture-proof | Solid |
| Area of use | A transport cart for 1 ea 20-50 litres cylinder | A universal transport cart that can carry all types of cylinders from 2 GENIE to 1 P45 cylinder | Optimal cart for transportation or storage of 2 ea 20 litres cylinders | Optimal cart for transportation or storage of 2 ea 50 litres cylinders, with a storage box that can be locked | Small cylinder cart perfect for 2 ea 5/10 litres cylinders, with a small storage box | FLAME® flexible gas cart is perfect for mobile work demanding a CE marked trolley that is approved for lifting, 2 ea 5/10 litres cylinder | An extension of the gas cylinder in mobile areas |

| Accessories available | | | | | | | |
|---------------------------------|---|---|---|---|--|---|----------|
| | | | | | | | Part no. |
| Solid wheel 250 mm | X | | | | | X | 318847 |
| Solid wheel 400 mm | | | | | | | 318848 |
| Puncture-proof wheel 260 mm | | X | X | | | | 318849 |
| Puncture-proof wheel 400 mm | | | | X | | | 334273 |
| Box for accessories, AGA FLAME® | | | | | | X | 320219 |
| Box, AGA FLAME® | | | | | | X | 320220 |
| Wheel A05, AGA FLAME® | | | | | | | 320221 |
| Clamp belt, AGA FLAME® | | | | | | X | 320224 |

* 334184 is with two storage boxes

Welding Helmet with Auto-Darkening Glass OHE410 DIN 9-13.

AGA's welding helmet has a focus on your safety. The welding helmet provides permanent protection against ultraviolet and infrared radiation, heat and sparks. Adjustable lens sensitivity makes this helmet suitable for different welding environments. Auto-darkening of shade level DIN 9-13. The welding helmet can be adjusted while wearing welding gloves and without having to take off the helmet.

| | Part no. |
|--------------------------------|----------|
| Welding Helmet OHE410 DIN 9-13 | 336228 |



Accessories and Spare Parts for OHE410 DIN 9-13.

| | Part no. |
|---------------------------------------|----------|
| OHE410 Inner Protective Lens (10 PCS) | 336261 |
| OHE410 TK03 Complete HG, Nuts, Bolts | 336262 |
| OHE410 Comfort Band 2-PC | 336263 |
| OHE410 Anti-Spatter Lens (10 PCS) | 336264 |
| OHE410 ADF Retainer + Thumb Screw | 336265 |

PLEASE NOTE: ADF is not available as spare parts.



TIG (GTAW)



MMA (SMAW)



PWA



MIG/MAG (GMAW)

Warning Signs.

Triangle warning sign of non-flammable material must be present at each storage location for gas cylinders or gas cylinder trolleys. The design can be seen from SÄIFS 1996:3 and AFS 1997:11.

| | Material | Format | Part no. |
|-------------------------|-----------|----------|----------|
| Open flame, prohibition | Plastic | Square | 334407 |
| Open flame, prohibition | Sticker | Square | 334408 |
| EX sign | Plastic | Triangle | 334405 |
| EX sign | Sticker | Triangle | 334406 |
| Gas under pressure | Aluminium | Square | 334403 |
| Gas under pressure | Sticker | Square | 334404 |



Leak Detection Spray TL4.

TL4 is used for checking the tightness of all systems containing gas or air under pressure. Sprayed directly onto the point to be checked. If even the slightest leak is present, clear bubbles are formed. TL4 is non-hazardous. It contains no harmful substances.

| Delivery form | Net weight g | Part no. |
|-------------------|--------------|----------|
| Aerosol packaging | 300 | 300820 |



Mounting Brackets for Cylinders.

Cylinder brackets are available for one and two gas cylinders. These comprise a wall bracket made of stainless steel EN 1.4301 and a chain made of galvanised steel. All cylinders must be secured with cylinder brackets to prevent them tipping over.

If a cylinder tips over, it can cause personal injury and material damage. If the cylinder valve is damaged, the cylinder can start to rotate out of control. Cylinders on ships and other mobile installations must be secured with a fixed bracket.

| Mounting brackets for cylinders | | |
|---------------------------------|-------------------|----------|
| Length mm | Qty gas cylinders | Part no. |
| 260 | 1 | 301937 |
| 550 | 2 | 301957 |



Back Frame.

| | Part no. |
|--|----------|
| Back frame for 2 x 5 litre gas cylinders | 305873 |

Fire Glove.

Fire protection gloves must always be placed in a clearly visible location adjacent to the gas cylinder stand. AGA's fire protection gloves meet the requirements according to CE Approved.

| | Part no. |
|------------|----------|
| Fire glove | 300904 |



Welding Hose.

The welding hose is an important part of the equipment from a safety perspective. In addition, this "last link in the gas distribution" must maintain the gas's purity through to the point of consumption.

AGA's welding and propane hoses are manufactured in accordance with EN.

The hoses are marked with gas type, dimensions and working pressure. All hoses are supplied in 40 m reels, with the exception of the black and blue/orange hoses.

- Red hose = Acetylene
- Blue hose = Oxygen
- Orange hose = Propane/Hydrogen
- Black hose = Shielding gas for gas shielded arc welding

Gas shielded arc welding is one of the welding processes that uses shielding gas as protection and a welding parameter: in the first instance TIG, MIG/MAG and plasma welding.



Note!

As the gases react differently to the rubber material in the hoses, the hoses are manufactured according to the different properties of the gases. It is therefore important to use the correct hose for the type of gas in question.

Single Hose and Twin Hose.

As gas hoses are made of rubber, they are affected by the external environment, e.g. ultraviolet radiation, which makes the rubber more brittle. It is therefore important to replace hoses frequently to avoid leaks.

| Single hose – 50 metre | | | |
|------------------------|---------------|------------------|--------------------|
| Colour | Dimension, mm | Type of gas | 50 m reel Part no. |
| Blue | 6.3 | Oxygen | 334453 |
| Blue | 10.0 | Oxygen | 334454 |
| Blue | 12.5 | Oxygen | 334449 |
| Orange | 6.3 | Propane/Hydrogen | 334490 |
| Orange | 8.0 | Propane/Hydrogen | 334494 |
| Orange | 10.0 | Propane/Hydrogen | 334493 |
| Black | 5.0 | Argon/Dry Flow | 334496 |
| Black | 6.3 | Argon/Dry Flow | 334498 |
| Black | 5.0 | Argon | 334502 |
| Black | 6.3 | Argon | 334499 |

| Twin hose – 50 metre | | | |
|----------------------|---------------|------------------|--------------------|
| Colour | Dimension, mm | Type of gas | 50 m reel Part no. |
| Blue/Red | 5.0–5.0 | Oxygen/Acetylene | 334455 |
| Blue/Red | 6.3–6.3 | Oxygen/Acetylene | 334481 |
| Blue/Red | 8.0–8.0 | Oxygen/Acetylene | 334482 |
| Blue/Orange | 6.3–6.3 | Oxygen/Propane | 334483 |
| Blue/Orange | 6.3–8.0 | Oxygen/Propane | 334503 |
| Blue/Orange | 10–10 | Oxygen/Propane | 334507 |

| Singel hose – 10 metre | | | |
|------------------------|---------------|----------------|--------------------|
| Colour | Dimension, mm | Type of gas | 10 m reel Part no. |
| Black | 5.0 | Argon/Dry Flow | 316720 |
| Black | 6.3 | Argon/Dry Flow | 316722 |

Recommendation for choice of hose dimension:
Welding hose, 20 metres long, with a diameter of Ø 6.3 mm, copes with cutting materials up to 250 mm thick.

This means that

- Hose Ø 6.3 mm can cope with all gas welding and normally gas cutting/heating
- It is easier to work with the equipment thanks to increased mobility

Pressure drop – example

- Hose Ø 6.3 mm, length 20 metres
- X21 handle with non-return valves
- X21 cutting attachment
- Cutting nozzle: COOLEX® A-317-5
- Regulator: UNICONTROL 500
- Pressure at:

| | | |
|-----------|------------|------------|
| Regulator | 8.5 bar | 10.0 bar |
| Torch | 5.2 bar | 6.2 bar |
| Gas flow | 28.000 l/h | 32.800 l/h |
- Pressure drop 3.3 bar 3.8 bar

Conclusion:

Select hose Ø 6.3 mm for cutting up to 250 mm.

Twin Hose.

Twin hose with compression couplings increases safety and facilitates installation and replacement of welding hose.

Compression couplings

- Mean that hose clips are not required, which facilitates the operation of torch handles during welding and cutting
- Ensure correct installation, which increases safety and saves time



| Twin hose with compression couplings and non-return valves BV 12 | | | | |
|--|-----------|------------------|---------------------|----------------------|
| Colour | Dimension | Non-return valve | 5 metre SB Part no. | 10 metre SB Part no. |
| Blue/Red (X11) | 5.0–5.0 | ¼" | 307680 | 305880 |
| Blue/Red (X21) | 6.3–6.3 | ⅜" | | 305034 |

AGA Quick Coupling.

AGA's patented quick couplings fit all of AGA's regulators, including older models. With quick couplings, hoses and torches can be replaced quickly and easily without the aid of tools.

Quick couplings for acetylene and hydrogen have red marking. Oxygen and other fuel gases are marked with blue.

| Quick coupling without hose fitting | |
|---|-----------------|
| Acetylene and Hydrogen | Part no. |
| Connection (female): LH G 3/8" | 300787 |
| Hose fitting (male) Ø 5.0 mm | 300869 |
| Hose fitting (male) Ø 6.3 mm | 300860 |
| Hose fitting (male) Ø 8.0 mm | 300859 |
| Quick coupling kit (female + male) | |
| Quick coupling kit Ø 5.0 mm | 305684 |
| Quick coupling kit Ø 6,3 mm | 305685 |

| Quick coupling without hose fitting | |
|---|-----------------|
| Oxygen and other gases | Part no. |
| Connection (female): G 3/8" | 300844 |
| Hose fitting (male) Ø 5.0 mm | 300858 |
| Hose fitting (male) Ø 6.3 mm | 300857 |
| Hose fitting (male) Ø 8.0 mm | 300885 |
| Quick coupling kit (female + male) | |
| Quick coupling kit Ø 5.0 mm | 305665 |
| Quick coupling kit Ø 6,3 mm | 305676 |
| Quick coupling kit Ø 8,0 mm | 305693 |

| 1. Quick coupling (female 3/8") for outlet point and regulator | | |
|--|-----------|-----------------|
| | | Part no. |
| Fuel gas | LH G 3/8" | 305639 |
| Oxygen | G 3/8" | 305653 |
| Argon | G 3/8" | 305636 |

| 2. Hose fitting (male) for quick coupling | | |
|---|-----|-----------------|
| Fuel gas | | Part no. |
| | 5.0 | 309413 |
| | 6.3 | 305640 |
| | 8.0 | 309475 |
| Oxygen | | |
| | 5.0 | 309412 |
| | 6.3 | 305648 |
| | 8.0 | 309474 |
| Argon | | |
| | 5.0 | 309411 |
| | 6.3 | 305644 |

| 3. Quick coupling (female) with hose fitting | | |
|--|-----|-----------------|
| Fuel gas | | Part no. |
| | 5.0 | 309416 |
| | 6.3 | 305632 |
| | 8.0 | 309476 |
| Oxygen | | |
| | 5.0 | 309417 |
| | 6.3 | 305634 |
| | 8.0 | 309477 |
| Argon | | |
| | 5.0 | 309418 |
| | 6.3 | 305628 |

Quick couplings for regulators/outlet points and gas hoses mean that connection and disconnection in a gas line system can be achieved quickly and easily.

Thanks to the automatic locking mechanism, it is possible to dismantle equipment under gas pressure. A secure, durable design as well as hard technical function tests ensure that AGA Quick Couplings maintain a high quality.



Quick coupling for oxygen



Hose fitting



Quick couplings in accordance with ISO 561.

The quick couplings are made of brass with hose fittings made of stainless steel.

All components are adapted for each gas type for which they are to be used. The quick couplings are simple to connect/disconnect without tools. The couplings may only be used on the low-pressure side.



305639



305640



305653



305648



305632



305640



305634



305648

Hose Fittings and Cap Nuts.

| Hose fittings for X11 Pro handle, G ¼" according to EN 560 | Qty | Part no. |
|--|-----|----------|
| Hose fitting Ø 5.0 mm | 2 | 300834 |
| Hose fitting Ø 6.3 mm | 2 | 300932 |

| Hose fittings for regulators and large torches, G ⅜" according to EN 560 | Qty | Part no. |
|--|-----|----------|
| Hose fitting Ø 5.0 mm | 2 | 300930 |
| Hose fitting Ø 6.3 mm | 2 | 300931 |
| Hose fitting Ø 8.0 mm | 2 | 300933 |
| Hose fitting Ø 10.0 mm | 2 | 300892 |

| Cap nuts | Qty | Part no. |
|--|-----|----------|
| For X11 – handle: Cap nut Acetylene LH G ¼"+Oxygen G ¼" | 1+1 | 300835 |
| For regulators and large torches: Cap nut acetylene LH G ⅜"+Oxygen G ⅜" | 1+1 | 300836 |
| Blanking plug ⅜" | | 301816 |



Extension Pieces.

Non-separable (whole)

| Hose dimension Ø mm | Qty in SB | Part no. | SB pack |
|---------------------|-----------|----------|---------|
| Extension piece | 5.0-5.0 | 2 | 300841 |
| Extension piece | 6.3-6.3 | 2 | 300832 |
| Extension piece | 8.0-8.0 | 2 | 300833 |
| Extension piece | 10.0-10.0 | 2 | 300912 |



Separable

| Hose dimension Ø mm | Qty in SB | Part no. |
|----------------------------|-----------|----------|
| 5.0-5.0 acetylene/oxygen | 1+1 | 300929 |
| 6.3-6.3 acetylene/oxygen | 1+1 | 300936 |
| 8.0-8.0 acetylene/oxygen | 1+1 | 300888 |
| 10.0-10.0 acetylene/oxygen | 1+1 | 300901 |

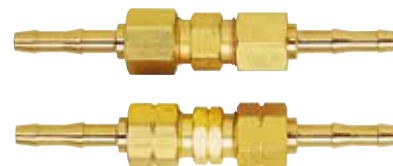

Centre Piece for Extension Pieces.

| | Part no. |
|--------------------------|----------|
| Centre piece LH G ⅜" | 300886 |
| Centre piece G ⅜" | 300870 |
| Centre piece LH G ¼" | 300896 |
| Centre piece G ⅜" – G ¼" | 300854 |



Hose Clips – Hose Holder.

| | Qty | Part no. |
|--------------------|-----|----------|
| Hose clip 08-14 mm | 4 | 300795 |
| Hose clip 13-20 mm | 2 | 300796 |



Balloon Inflator.

Intended for connection to helium bottles with gas balloon quality, for filling rubber balloons or aluminium balloons.

| | Part no. |
|-----------------|----------|
| Ballon inflator | 301051 |
| Gasket | 311816 |



Gas Saver GS 10.

Gas saver for the fuel gases acetylene and propane, as well as oxygen.
Adjustable Bunsen-type flame. No soot formation during lighting and extinguishing.

Maximum working pressure 4.5 bar. Supplied with hose fittings for Ø 5.0, 6.3 and 8.0 mm.

In addition to saving gas, GS 10 has an environmental benefit in that there are less nitrous gases from the small Bunsen flame compared to a free-burning welding or cutting flame.

| | Part no. |
|-------------------------------|----------|
| Gas saver GS 10 for acetylene | 300838 |
| Gas saver GS 10 for propane | 323294 |
| Valve insert complete GS10 | 300822 |
| Pressure plate | 300139 |
| Lever | 300902 |
| Bunsen burner | 300839 |



Gas Lighter.

The gas lighter comprises a sprung bar that is fitted with replaceable flint stones.

| | Qty | Part no. |
|--------------|-----|----------|
| Gas lighter | | 300895 |
| Flint stones | 5 | 300781 |



Welding and Inspection Mirror.

Mirror with magnetic mount and flexible arm. The mirror is secure with a ball joint on the arm and is easy to adjust to different positions.

Length: 500 mm

Robust magnetic mount: 480 N

| | Qty | Part no. |
|--|-----|----------|
| Welding and inspection mirror with magnet and flexible handle | 1 | 300893 |
| Welding and inspection mirror with ball joint and fixed handle | 1 | 300780 |
| Spare mirror made of polished stainless steel | 1 | 300894 |

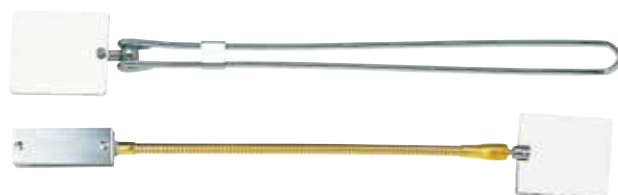

Cleaning Needles..

Grooved cleaning needles for cleaning outlet ducts in welding and cutting nozzles.
The cleaning needles are supplied as a sheet in a metal box.

| Cleaning needles. | | |
|-------------------------------|----------------|----------|
| | Dimension Ø mm | Part no. |
| X11 – X21 | 0.5–3.0 | 305435 |
| X11 – X21 – x 31 (steel case) | | 305554 |
| Long | 0.4–2.5 | 300559 |



Flux for Gas Welding.

Gas welding is a versatile welding process with a large area of application. Gas welding is excellent for welding unalloyed and low-alloy steel.

The choice of flux – welding wire – must take place with regard to the parent material and its composition. Consult your material supplier if in doubt.

H 44.

H 44 is a bright-drawn welding wire intended for unalloyed construction steel and some pressure vessel steel with a highest minimum breaking strength of 430 N/mm². H44 is widely used for gas welding pipes. Approved in accordance with EN 12536.

H 44 Mo.

H 44 Mo is a bright-drawn welding wire intended for unalloyed and low-alloy construction steel and some pressure vessel steel with a highest minimum breaking strength of 430 N/mm². H 44 Mo is supplemented with 0.5 % molybdenum (Mo) and consequently has a slightly wider area of application. Approved in accordance with EN 12536.



| | Dimension Ø mm | Part no. |
|----------------|----------------|----------|
| H 44 | 1.60 *700 | 300983 |
| | 2.00 *700 | 300982 |
| | 2.50 *700 | 300977 |
| | 3.15 *700 | 300981 |
| | 4.00 *700 | 300980 |
| | 5.00 *700 | 300984 |
| H 44 Mo | 2.00 *700 | 300978 |
| | 2.50 *700 | 300979 |
| | 3.15 *700 | 300985 |

Note!

Pay attention to how the parent material is sealed, as both silicon-sealed and aluminium-sealed steel are available on the market. With aluminium-sealed steel, there is a risk of pores in the welded items. In this case, select H 44 Mo.

Supplied in 5 kg boxes.

| Designation | Suitable for steel | | Principal analysis % | | | | | |
|-------------|--------------------|-----------------|----------------------|------------|--------------|---------------|--------------|-----------|
| | Swedish Std SS | European Std EN | C Carbon | Si Silicon | Mn Manganese | Mo Molybdenum | P Phosphorus | S Sulphur |
| H 44 | 1232 | P 195 | | | | | | |
| | 1305 | | | | | | | |
| | 1306 | | | | | | | |
| | 1311 | S 235 JR | | | | | | |
| | 1312 | S 235 JRG2 | | | | | | |
| | 1330 | P 235 GH | 0.11 | 0.21 | 1.00 | – | 0.025 | 0.020 |
| | 1411 | | | | | | | |
| | 1412 | S 275 JR | | | | | | |
| | 1430 | P 265 GH | | | | | | |
| | H 44 Mo | 1232 | P 195 | | | | | |
| 1305 | | GS 45 | | | | | | |
| 1306 | | | | | | | | |
| 1311 | | | | | | | | |
| 1312 | | S 235 JRG2 | | | | | | |
| 1330 | | P 235 GH | | | | | | |
| 1411 | | | 0.11 | 0.21 | 1.00 | 0.50 | 0.025 | 0.020 |
| 1412 | | S 275 JR | | | | | | |
| 1430 | | P 265 GH | | | | | | |
| 1434 | | P 265 | | | | | | |
| 1435 | P 265 | | | | | | | |
| 2912 | 16 Mo3 | | | | | | | |



Jet Freezer.

Jet freezing is used when repairing and supplementing pipe systems that contain water. The jet freezer's casing is simple to secure around the pipe. Inside the casing, dry ice is produced at a temperature of -78°C . The water in the pipe freezes and forms an ice plug, which effectively stops the continuing flow.

Dry ice is formed when the gas (CO_2) in liquid form is allowed to expand under atmospheric pressure. In order to extract carbon dioxide in liquid phase, we recommend a gas cylinder with a riser pipe. A complete jet freezer comprises a casing, HT hose. Models 80 and 100 are equipped with two nozzles and double hoses, as well as a T-piece.

In order to know how much gas is in the gas cylinder, it can be weighed. The cylinder's tare (weight without gas) is stamped on the collar. Spring scales graduated 0–25 kg are available as an accessory. It takes approximately 13 minutes to freeze a 28 mm pipe with a model 22 casing, and this requires approximately 1.2 kg of carbon dioxide. To ensure that the ice plug does not thaw, a small amount of carbon dioxide needs to be released into the casing now and then to ensure it is constantly filled with dry ice.

| | Part no. |
|-----------------------------|----------|
| Jet Freezer complete | |
| Mini | 311341 |
| Model 22 | 311342 |
| Model 42 | 311343 |
| Model 80 | 311344 |
| Parts | |
| Casing, model Mini | 311346 |
| Casing, model 22 | 311347 |
| Casing, model 42 | 311348 |
| Casing, model 80 | 311349 |
| Casing, model 100 | 311350 |
| HT hose | 311351 |
| T-piece | 311352 |
| Spring scales 0–25 kg | 311355 |
| Gasket | 311610 |

Guide values for the consumption of carbon dioxide and freezing time for various pipe diametres

| Casing model | Pipe diametre | | | | | | | | | |
|--------------|---------------|---------|--------|--------|--------|--------|--------|---------|---------|--|
| | 15 mm | 22 mm | 28 mm | 42 mm | 54 mm | 65 mm | 80 mm | 90 mm | 100 mm | |
| Model 22 | 3 min | 6 min | 13 min | | | | | | | |
| Model 42 | 3 min | 5 min | 11 min | 17 min | | | | | | |
| Model 80 | | | | 20 min | 35 min | 50 min | 75 min | | | |
| | 0.5 kg | 0.75 kg | 1.2 kg | 2.5 kg | 4.1 kg | 6.4 kg | 9.1 kg | 12.7 kg | 16.4 kg | |

The time it takes to freeze and thaw an ice plug is dependent on the thickness of the pipe, the temperature of the water in the pipe and the ambient temperature. The jet freezer does not damage the pipes, as freezing takes place rapidly and the freezing area is restricted.

GENIE® Cylinder Extension Handle.

The extension handle is designed for use in conjunction with the GENIE® cylinder wheel unit. The extension simply clips onto the handle area of the GENIE® cylinder and can then be extended to the length that is most comfortable for you.

| | Part no. |
|------------------|----------|
| Telescope handle | 331283 |



GENIE® Cylinder Wheel Unit.

The cylinder wheel unit fits any size GENIE® cylinder. The cylinder simply slips into the wheel unit and is locked in place using two diametrically opposed claw clamps.

| | Part no. |
|-----------|----------|
| Wheel kit | 331282 |



GENIE® Regulators.

All the GENIE® regulators are manufactured to meet the stringent ISO 2503 safety and performance standards, providing exceptionally consistent flow characteristics and pressure stability as well as ease of use.

| Type of gas | Regulator and gas identification ring colour | Inlet pressure | Outlet pressure/flow | Inlet connection | Outlet connection | Part no. |
|--|--|----------------|----------------------|------------------|-------------------|----------|
| GENIE® standard regulators | | | | | | |
| Argon/MISON® | Green | 300 bar | 0-30 l/min | W 30 x 2 | G 3/8" | 335877 |
| Nitrogen | Black | 300 bar | 0-10 bar | W 30 x 2 | G 3/8" | 335876 |
| Nitrogen | Black | 300 bar | 0-50 bar | W 30 x 2 | G 3/8" | 335877 |
| GENIE® PRO regulators | | | | | | |
| Argon/MISON® | Green | 300 bar | 0-10 bar | W 30 x 2 | G 3/8" | 333914 |
| Nitrogen | Black | 300 bar | 200 bar | W 30 x 2 | G 3/8" | 333915 |
| Quick connector for GENIE® ViPR – Argon/MISON | | | | | | |
| Quick connector 6.3 mm | | | | | | 335472 |
| Quick connector 5.0 mm | | | | | | 336031 |



Rotam Plus.

| | Part no. |
|-----------------------------|------------|
| Single Rotam Plus | 300100 |
| Double Rotam Plus | 300100 x 2 |
| T-piece incl. blanking plug | 300104 |
| Blanking plug | 301816 |

Se page 20.



A Member of
The Linde Group

AGA

GENIE[®] gas cylinder.

For a better work environment.

Lightweight cylinder in a unique solid construction. Attachable wheels and telescopic handles make it easy to move the cylinder without need for heavy lifting.

The 300 bar contains up to 45% more gas, and the digital display provides information that helps facilitate your work.

GENIE[®] is available with Argon, Nitrogen and MISON[®] shielding gases.

AGA – ideas become solutions.



Lightweight.
300 bar - more gas.



Intelligent Digital
Display



Mobile



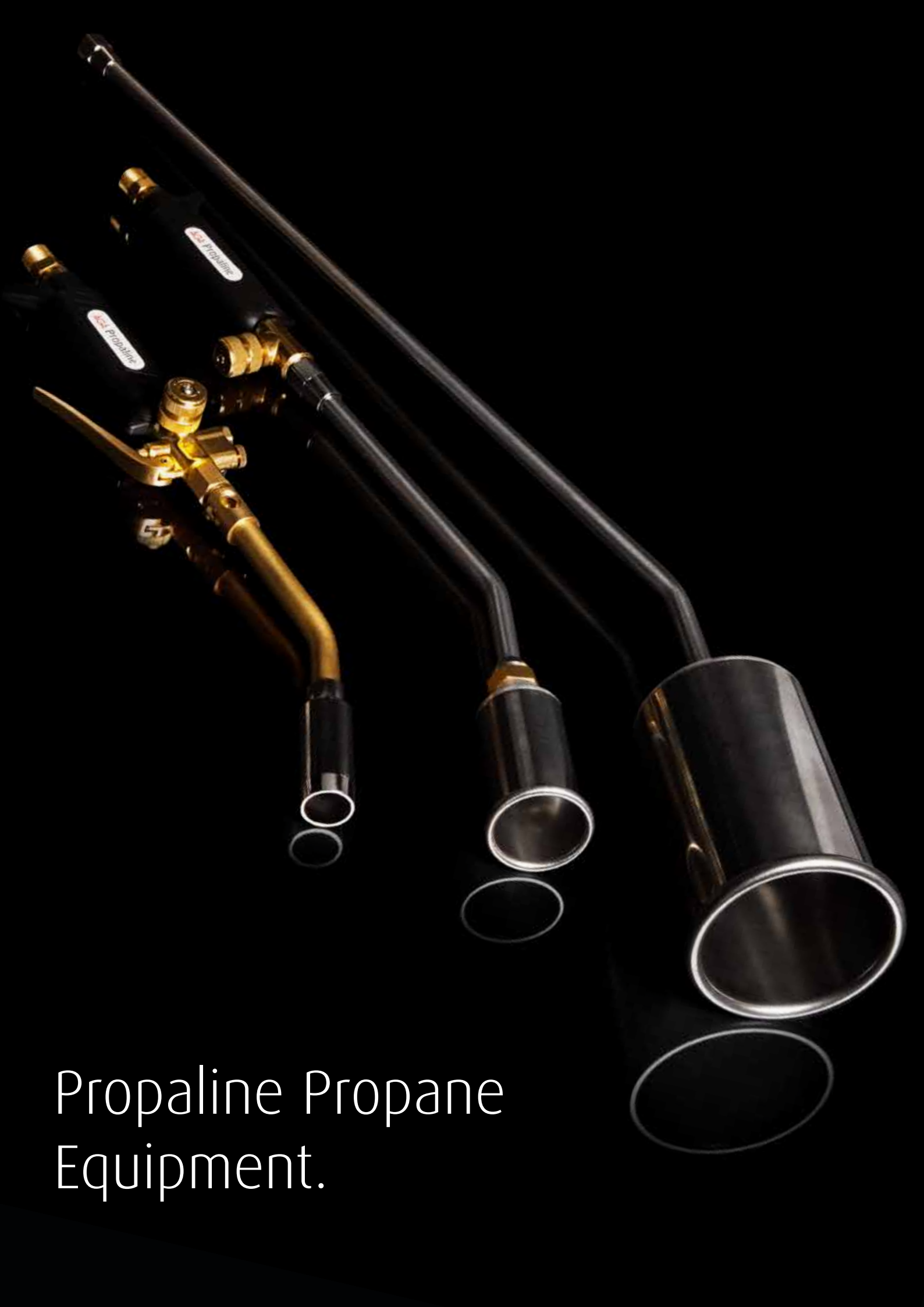

Propane Propane
Equipment.

Regulators.

The pressure regulator keeps a stable working flow and pressure independent of fluctuations in temperature and inlet pressure. It is suitable for applications with the AGA Propaline equipment. The regulator has an integrated hose brake safety device and are manufactured in accordance with EN ISO 16129.

| Regulators | | | | | | | Part No |
|--|------------------|-------------------|--------------------|---------------------|----------------|-----------------------------|---------|
| | Inlet connection | Outlet connection | Inlet pressure bar | Outlet pressure bar | Flow rate kg/h | Integrated hose brake valve | |
| Finland, Baltics | | | | | | | |
| 4 Bar Fix SBS, Kombi | | | | | | | |
| | W 21.8 x 1/4" | G 3/8" LH | 16 | 4 | 14 | Yes | 336114 |
| Finland, Baltics | | | | | | | |
| 4 Bar Adjustable SBS, Kombi | | | | | | | |
| | W 21.8 x 1/4" | G 3/8" LH | 16 | 0.5-4 | 14 | Yes | 336115 |
| Sverige, Norge | | | | | | | |
| 4 Bar fixed | | | | | | | |
| | NGO 0,885 x 1/4" | G 3/8" LH | 16 | 4 | 14 | Yes | 336605 |
| Finland, Norway, Denmark, Baltics | | | | | | | |
| Kosan Type L.P.G Click on | | | | | | | |
| | | G 3/8" LH | 16 | 0.5-2.0 | 4 | No | 336159 |



Accessories

| | Part No |
|---------------------------------------|---------|
| Gasket Propane regulator Din (10 Pcs) | 336321 |

Hose Brake Valves.

The hose brake valve safety device prevents gas leakage if the hose gets damaged or disconnected. The valve closes if there is a sudden increase of gas flow. If the valve gets activated it is resettable when the problem with the hose has been solved. The hose break valve shall be connected to the regulator outlet.

| Hose break valve | | | | | |
|------------------|------------------|-------------------|------------------------------------|----------------------------------|---------|
| | Inlet connection | Outlet connection | Nominal flow rate at 1,5 bar, kg/h | Nominal flow rate at 4 bar, kg/h | Part No |
| SBS 1 | G 3/8" LH F | G 3/8" LH M | 1.5 | 2.2 | 336110 |
| SBS 2 | G 3/8" LH F | G 3/8" LH M | 4.0 | 6.0 | 336111 |
| SBS 3 | G 3/8" LH F | G 3/8" LH M | 6.0 | 8.5 | 336112 |
| SBS 4 | G 3/8" LH F | G 3/8" LH M | 10.0 | 14.0 | 336113 |



Propane Hose with Compression Couplings.

| Propane hose with compression couplings | | | | |
|---|-----------|-------------|--------|---------|
| Colour | Dimension | Hosefitting | Length | Part No |
| Orange | 6 mm | 3/8"-3/8" | 10 m | 336293 |
| Orange | 6 mm | 3/8"-3/8" | 5 m | 336320 |

Handles.

Handles are fitted with a valve that makes it easy to control flame continuously. The handle with lever provides the opportunity to switch between pilot and main flame. Combined shut-off valve and control valve.

| Shank fixed | | | | | | | |
|---------------------|------------------|---------------|--------|-----------|------------------|-------------------|---------|
| | Working pressure | Capacity kg/h | Lenght | Weight kg | Inlet connection | Outlet connection | Part No |
| Pilot flame | Up to 4 bar | 12 | 195 mm | 0.36 | G 3/8" LH | G 3/8" | 336052 |
| Without pilot flame | 4 bar | 12 | 195 mm | 0.36 | G 3/8" LH | G 3/8" | 336056 |



Accessories

| Rotating hose nipple | | | |
|----------------------|-------------|------------|---------|
| Angle | Hose nipple | Connection | Part No |
| 60° | 6.3 mm | G 3/8" LH | 336088 |

| Hose connection | | | |
|-----------------|-------------|------------|---------|
| | Hose Nipple | Connection | Part No |
| | 6.3 mm | G 3/8" LH | 336283 |



Extension Pipes.

Choose between a wide range of extension pipes in different lengths for connection to the handle. The extension pipes are made of stainless steel.

Accessories

| Extension pipe | |
|----------------|---------|
| Lenght | Part No |
| 150 mm | 336097 |
| 220 mm | 336098 |
| 350 mm | 336099 |
| 600 mm | 336100 |
| 750 mm | 336101 |
| 1000 mm | 336102 |



| Fork pipe | | | | |
|-----------|------------------|-------------------|--------|---------|
| | Inlet connection | Outlet connection | Width | Part No |
| 2 | M20 x 1 | 2 x M20 x 1 | 150 mm | 336094 |
| 4 | M20 x 1 | 4 x M20 x 1 | 450 mm | 336095 |

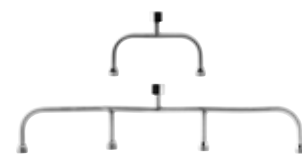

| Burner support | |
|----------------|---------|
| Width | Part No |
| 125 mm | 336096 |



Heating Torches.

In the propane equipment it is the heating torch that creates an effective wind resistant flame. Choose between a range of standard burners for different jobs, for example: Heating, precision work and for various roofing, wall and construction work. The heating torch are especially suitable for large, heat-intensive jobs.

| Heating torch | | | | | | |
|---------------|----------|------------------|----------------------|------------------|-------------|---------|
| | Diameter | Inlet connection | Working pressure bar | Consumption kg/h | Power kW | Part No |
| HT-I 30 | 30 mm | M20 x 1 | 1-4 | 0.66-1.05 | 8.55-13.59 | 336089 |
| HT-I 40 | 40 mm | M20 x 1 | 1-4 | 1.2-1.9 | 15.44-24.48 | 336090 |
| HT-I 50 | 50 mm | M20 x 1 | 1-4 | 3.78-7.6 | 48.7-97.7 | 336091 |
| HT-I 60 | 60 mm | M20 x 1 | 1-4 | 5.0-9.7 | 64-125 | 336092 |
| HT-I 80 | 80 mm | M20 x 1 | 1-4 | 5.6-10.6 | 72-136 | 336093 |



Soldering Torch.*

Point burner for hard and soft soldering. Point burners are especially suitable for hard and soft soldering of copper pipes and pipe fittings.

| Torch | | | | | | |
|-------|--------|------------------|----------------------|-----------------|-----------|---------|
| | Lenght | Inlet connection | Working pressure bar | Consumption g/h | Power kW | Part No |
| BT 3 | 120 mm | G 3/8" | 1.5-2.5 | 30-39 | 0.39-0.5 | 336107 |
| BT 5 | 120 mm | G 3/8" | 1.5-2.5 | 54-66 | 0.69-0.85 | 336108 |
| BT 7 | 138 mm | G 3/8" | 1.5-2.5 | 162-210 | 2.08-2.7 | 336109 |



Brazing Torch.*

Turbo torch for hard and soft brazing, these burners are adapted for work requiring low heat and power, eg Soft soldering and less Brazing works, as well as heating and goldsmith work. The turbo torch gives an optimal flame, which heats different materials with large surfaces both quickly and evenly. The flame, which comes from several holes, surrounds pipes efficiently and in the best way possible.

| Torch TT | | | | | | |
|----------|----------|------------------|----------------------|-----------------|-----------|---------|
| | Diameter | Inlet connection | Working pressure bar | Consumption g/h | Power kW | Part No |
| TT-I 12 | 12 mm | G 3/8" | 1.5-2.5 | 63-112 | 0.8-1.44 | 336103 |
| TT-I 14 | 14 mm | G 3/8" | 1.5-2.5 | 210-338 | 2.7-4.35 | 336104 |
| TT-I 17 | 17 mm | G 3/8" | 1.5-2.5 | 272-384 | 3.5-4.9 | 336105 |
| TT-I 20 | 20 mm | G 3/8" | 1.5-2.5 | 442-550 | 5.66-7.08 | 336106 |



* Typically used with the shank without pilot flame (336056).

Heating and Brazing Kits.*

Professional propane equipment in customized kits for easy start up.



| Propane heating kit | | | | | | | |
|---|------------------|-------------------|-------------|----------------|---------------|-----------------------|---------|
| | Shank | Regulator | Hose | Extension pipe | Heating torch | Hose brake valve | Part No |
| Finland, Norway, Denmark, Baltics Medium performance | With pilot flame | Click-On | 5 m; 6.3 mm | 350 mm | HT-I 40 | SBS2 | 336116 |
| Finland, Baltics High performance | With pilot flame | W 21,8 x 1/14" | 5 m; 6.3 mm | 600 mm | HT-I 60 | Included in regulator | 336117 |
| Sweden, Norway High performance | With pilot flame | NGO 0,885 x 1/14" | 5 m; 6.3 mm | 600 mm | HT-I 60 | Included in regulator | 336604 |



| Propane soldering and brazing kit | | | | |
|---|-----------|-----------|-------------|---------|
| Shank | Regulator | Hose | Turbo torch | Part No |
| Finland, Norway, Denmark, Baltics With pilot flame | Click on | 5 m; 5 mm | TT-I 20 | 336118 |

*The regulators have a click-on or W 21,8 x 1/14" inlet connection.

Additional
Information.



Equipped for Gas Welding.

During all welding – consider the fire risk.

Fire is the main risk when using gas equipment for welding, cutting and soldering. Fire can occur easily at a workplace that is poorly delimited and has too much flammable dust and debris, perhaps with a raised oxygen level, and with an ignition source in the vicinity. Other causes of fire can include excessive working pressure or incorrect equipment. Lack of knowledge and negligence can also eliminate the equipment's built-in safety features.

01. Regulator
02. Flashback arrestor
03. Welding hose
04. Non-return valves on the torch handle
05. Gasket between handle and insert
06. The nozzle is the cutting and welding tool's most exposed part. Look after it!
07. Fire glove
08. Securely stored gas cylinders.
Secure chain on a wall or a cylinder trolley
09. Warning signs
10. Yellow card

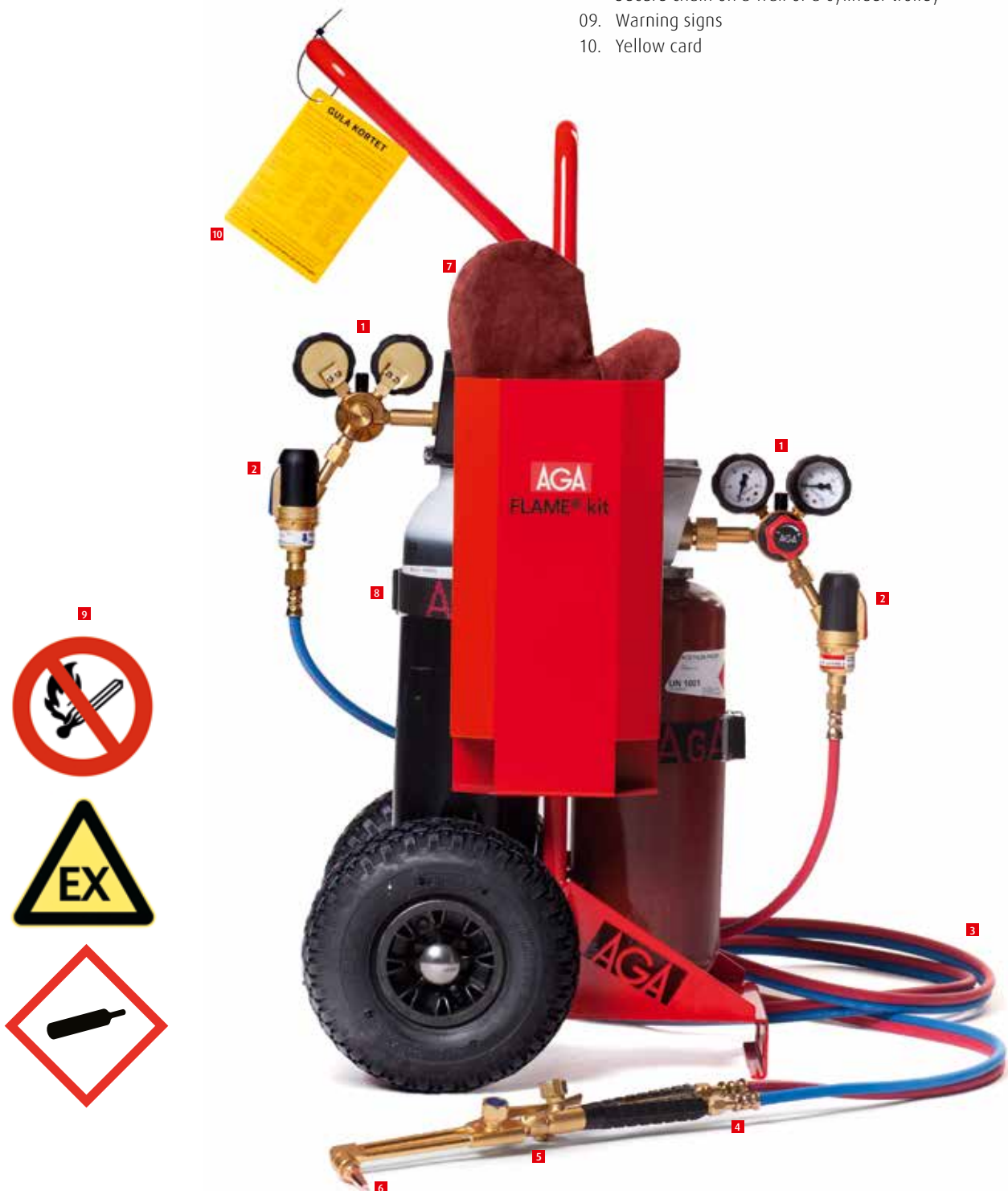

Checklist.

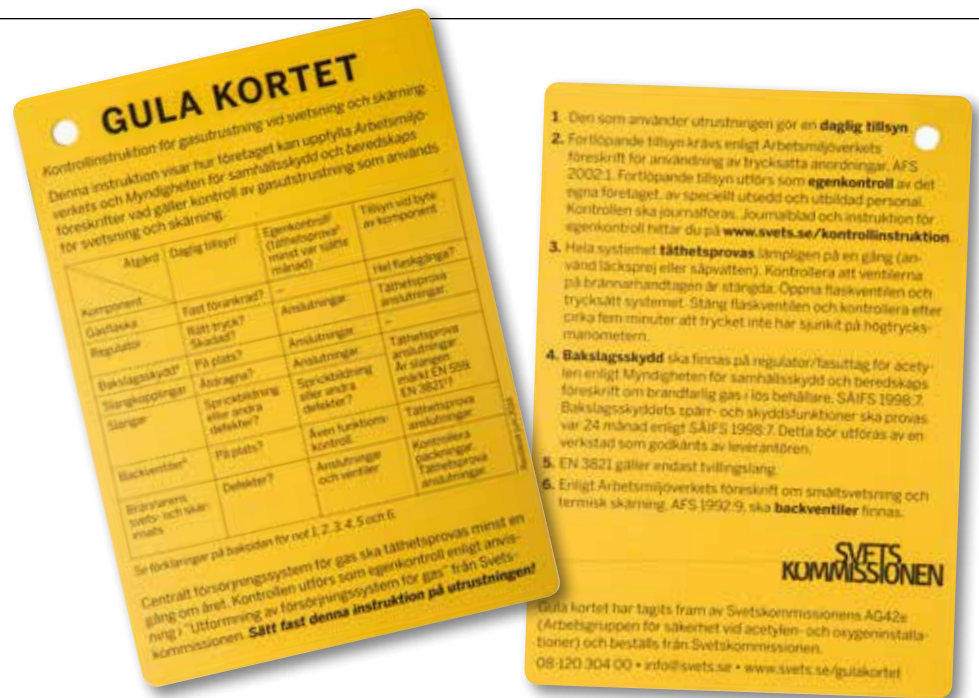

| Checklist / safe gas equipment | | Yes | No |
|--|---|--------------------------|--------------------------|
| 1. Regulator | | | |
| | Is the gasket in good condition? | <input type="checkbox"/> | <input type="checkbox"/> |
| | Is there a spare gasket? | <input type="checkbox"/> | <input type="checkbox"/> |
| | Is the regulator undamaged? | <input type="checkbox"/> | <input type="checkbox"/> |
| 2. Flashback protection | | | |
| | Is flashback protection in place? Requirement for acetylene, recommended for oxygen | <input type="checkbox"/> | <input type="checkbox"/> |
| | Connections OK? | <input type="checkbox"/> | <input type="checkbox"/> |
| The flashback protection's functions must be tested every 24 months in accordance with IFS 1997:2 This must be performed by a workshop approved by the supplier. Has a test been performed in the past 24 months? | | | |
| 3. Welding hose | | | |
| | Are there any cracks? If so, replace the hose package | <input type="checkbox"/> | <input type="checkbox"/> |
| | Is the welding hose suitable for the gas type? Red – Acetylene Blue – Oxygen Orange – LPG | <input type="checkbox"/> | <input type="checkbox"/> |
| 4. Non-return valve | | | |
| | Is there a non-return valve in the torch handle? Perform the function check (blow from the rear) | <input type="checkbox"/> | <input type="checkbox"/> |
| 5. Gasket between handle and insert (only applies to combi torches) | | | |
| | Are the seat and the gasket in good condition? | <input type="checkbox"/> | <input type="checkbox"/> |
| 6. Cutting nozzle/Welding attachment | | | |
| | Is the nozzle/insert undamaged? | <input type="checkbox"/> | <input type="checkbox"/> |
| | Is the seat in good condition? | <input type="checkbox"/> | <input type="checkbox"/> |
| 7. Fire glove | | | |
| | Is there a fire glove? Recommended | <input type="checkbox"/> | <input type="checkbox"/> |
| 8. Gas cylinders | | | |
| | Are the cylinders at no risk of tipping over (anchored)? | <input type="checkbox"/> | <input type="checkbox"/> |
| 9. Warning signs | | | |
| | | <input type="checkbox"/> | <input type="checkbox"/> |
| 10. Test airtightness (leak-trace) of the entire equipment according to point 3 on the yellow card | | | |
| | | <input type="checkbox"/> | <input type="checkbox"/> |
| 11. Yellow card "Inspection Instructions" | | | |
| | Secured to the equipment | <input type="checkbox"/> | <input type="checkbox"/> |

The inspections described above must be logged and archived according to the Swedish Welding Commission template. This template can be downloaded from the Swedish Welding Commission website, www.svets.se

Safety.

The Gas Cylinders.

- Most cylinders in AGA's range are fitted with fixed valve protection
- Fixed valve protection may not be removed from the cylinders
- Valve protection is not approved for crane lifting

The Regulators.

Before installing the regulator, check that:

1. The control wheel is unscrewed so that the spring tension has ceased
2. The O-ring is in perfect condition

The Hoses.

- Connect the hoses to the hose fittings on the regulator and the flashback arrestor
- Secure the connections with hose clips/compression couplings
- Use AGA's welding hose. This is approved for welding gases

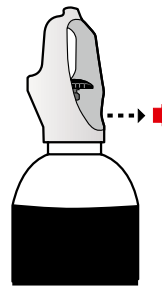

Note!

After completing the work or in the event of extended stoppages – Close the cylinder valve – Empty the hoses – Unscrew the control wheel until the spring tension has ceased.

Always use original O-rings and gaskets!

- Connect the regulators to the relevant gas cylinder
- Tighten the nuts moderately by hand. Applies to hand nuts

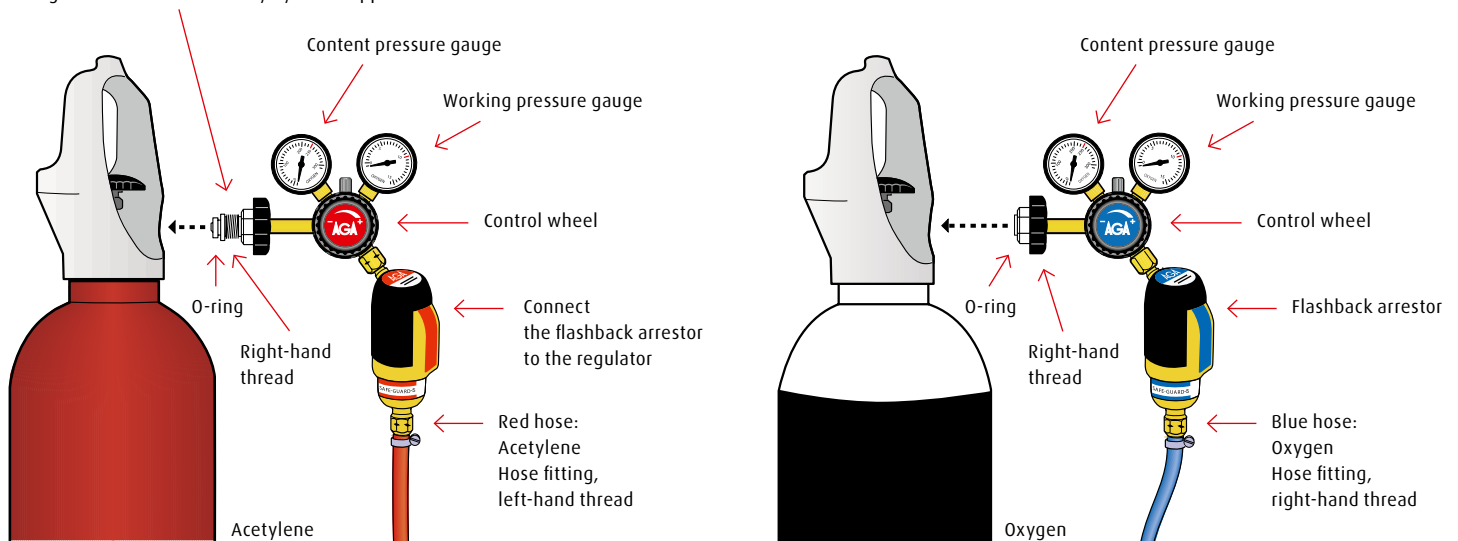

The content pressure gauge shows the cylinder pressure • The working pressure gauge shows the working pressure that is set with the control wheel

Calculating the content in the acetylene cylinder.

The gas content in an acetylene cylinder cannot be calculated exactly using the pressure because the acetylene's dissolubility in acetone is greatly affected by the ambient temperature. The content must therefore be calculated by means of weighing. As a guide, however, it is possible to calculate the approximate content by multiplying the reduction valve pressure in bar by the acetylene cylinder's volume in litres. Then multiply the result by 10.

Example A50

50 l in volume, 7 bar.

The approximate gas content is $50 \times 7 \times 10 = 350$ l per cylinder = 3.5 m³ gas, which is equivalent to 3.5 kg.

Emptying speed for manual work

In the event of high consumption of acetylene, it is advisable to check that the cylinders are not being emptied too quickly. Long-term use (more than 25 % per hour of the cylinder's content) should be avoided. In the event of a shorter consumption period (approx. 30 min), the emptying speed can be increased to the equivalent of 50 % per hour of the cylinder's total gas content. High consumption of acetylene occurs during heating, welding and flame cleaning, or when several torches are connected to the same cylinder(s).

In the event of 5 minutes of consumption, the emptying speed can be increased to 75 % of the cylinder's total gas content.

Information.

Lighting injector torch

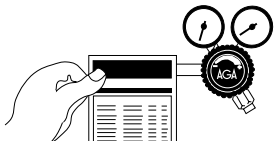

1. Set the pressure

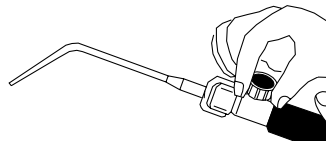

2. Open the oxygen valve

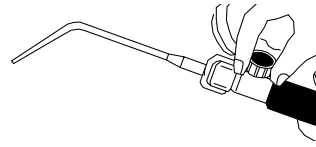

3. Open the fuel gas valve

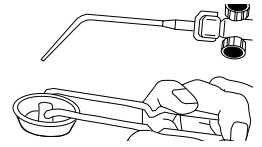

4. Light the torch

Extinguishing injector torch

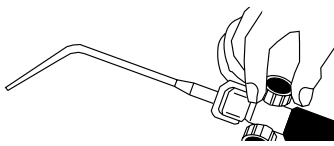

1. Close the fuel gas valve
2. Close the oxygen valve
3. Close the cylinder valve

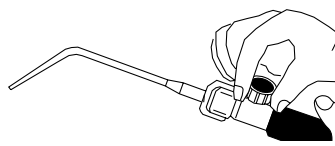

4. Relieve the hose pressure
5. Relieve the load on the regulator

Lighting and extinguishing pressure torch

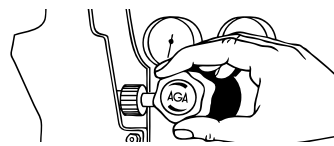

1. Set the working pressure on the cylinder regulators.

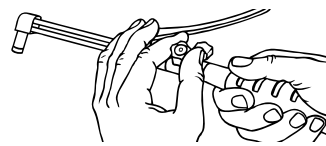

2. Open the oxygen valve on the handle fully.

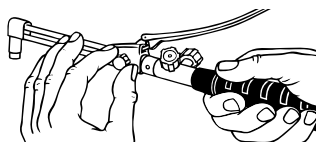

3. Open the oxygen valve on the cutting attachment and allow the oxygen to flow freely.

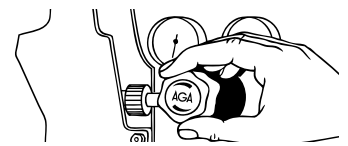

3a. Adjust the pressure on the oxygen regulator to the required level, see the cutting table.

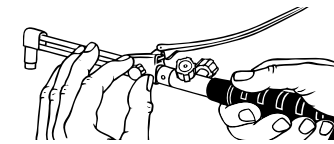

3b. Then close the oxygen valve on the cutting attachment until only a little gas is flowing out.

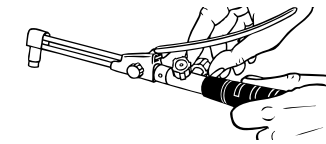

4. Open the acetylene valve on the torch handle approximately half a turn.

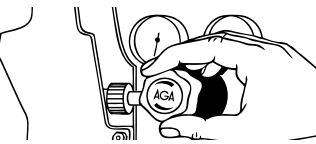

4a. Adjust the acetylene regulator until the cylinder reaches the required pressure, see the cutting table.

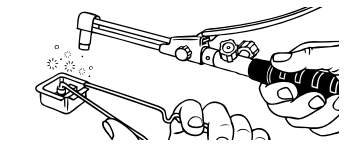

5. Light the flame (use gas lighter).

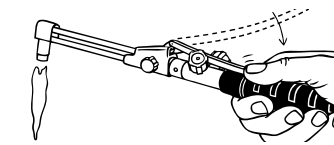

7a. Press and hold the rocker arm for the cutting oxygen.

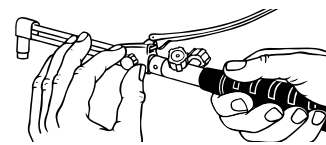

7b. Adjust the flame with the valve on the cutting attachment until you have a clear core flame immediately after the cutting nozzle.

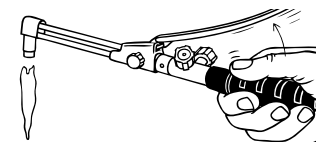

8+9. Release the rocker arm. The equipment is now ready for cutting.

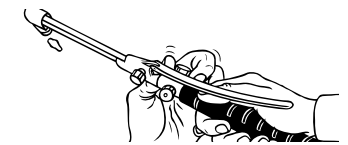

10. Close the acetylene valve on the handle.

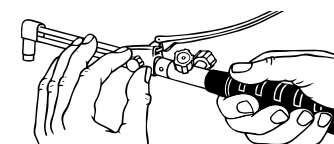

11a. Close the oxygen valve on the cutting attachment.

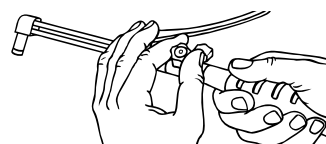

11b. When you leave the equipment after completing work: also close the oxygen valve on the handle.

Getting ahead through innovation.

With its innovative concepts, AGA is playing a pioneering role in the global market. As a technology leader, our task is to constantly raise the bar. Traditionally driven by entrepreneurship, we are working steadily on new high-quality products and innovative processes.

AGA offers more. We create added value, clearly discernible competitive advantages and greater profitability. Each concept is tailored specifically to meet our customers' requirements – offering standardised as well as customised solutions. This applies to all industries and all companies regardless of their size.

AGA – ideas become solutions

Sweden
AGA Gas AB
www.aga.se

Norway
AGA AS
www.aga.no

Iceland
ISAGA ehf
www.aga.is

Latvia
AGA SIA
www.aga.lv

Finland
Oy AGA Ab
www.aga.fi

Denmark
AGA A/S
www.aga.dk

Estonia
AS Eesti AGA
www.aga.ee

Lithuania
AGA UAB
www.aga.lt